

ES4-2071 & NO. 2274
RICHARD B FONES JR
25 BALTIMORE - ANNAPOLIS
BLVD - FERNDALE
GLEN BURNIE MD 21061

July, 1974 □ 75 cents

Electronic Servicing



A HOWARD W. SAMS PUBLICATION

TV from
satellite
to home

Motorola AGC

Zenith Repairs

PTS ELECTRONICS

HOME OFFICE—INDIANA:
5233 S. HWY. 37
BLOOMINGTON, INDIANA 47401
TEL. 812, 824-9331

ALABAMA:
524 32ND ST. SOUTH
BIRMINGHAM, ALA. 35222
TEL. 205, 323-2647

CALIFORNIA—NORTH:
4511 AUBURN BLVD.
SACRAMENTO, CALIF. 95841
TEL. 916, 482-6220

CALIFORNIA—SOUTH:
5111 UNIVERSITY AVE.
SAN DIEGO, CALIF. 92105
TEL. 714, 280-7070

COLORADO:
4958 ALLISON ST.
ARVADA, COLO. 80001
TEL. 303, 423-7080

FLORIDA—NORTH:
12934 N.W. 7TH AVE.
MIAMI, FLA. 33168
TEL. 305, 685-9811

FLORIDA—SOUTH:
1918 BLANDING BLVD.
JACKSONVILLE, FLA. 32210
TEL. 904, 389-9952

INDIANA:
5233 S. HWY. 37
BLOOMINGTON, IND. 47401
TEL. 812, 824-9331

KANSAS:
3116 MERRIAM LANE
KANSAS CITY, KANSAS 66100
TEL. 913, 831-1222

LOUISIANA:
2914 HYTCHWOOD DRIVE
METRIE, LOUISIANA 70033
TEL. 504, 885-2349

MARYLAND:
1105 SPRING ST.
SILVER SPRING, MD. 20910
TEL. 301, 565-0025

MASSACHUSETTS:
191 CHESTNUT ST.
SPRINGFIELD, MASS. 01103
TEL. 413, 734-2737

MICHIGAN:
13703 W. EIGHT MILE RD.
DETROIT, MICH. 48235
TEL. 313, 862-1783

MINNESOTA:
815 W. LAKE ST.
MINNEAPOLIS, MINN. 55408
TEL. 612, 824-2333

MISSOURI:
8456 PAGE BLVD.
ST. LOUIS, MO. 63130

NEW YORK:
993 SYCAMORE ST.
BUFFALO, N.Y. 14212
TEL. 716, 891-4935

NEW YORK CITY—NEW JERSEY:
158 MARKET ST.
E. PATERSON, N.J. 07407
TEL. 201, 791-6380

NORTH CAROLINA:
724 SIEGLE AVE.
CHARLOTTE, N.C. 28205
TEL. 704, 332-8007

OHIO:
5682 STATE RD.
CLEVELAND, OHIO 44134
TEL. 216, 845-4480

OKLAHOMA:
3007 N. MAY
OKLAHOMA CITY, OKLA. 73106
TEL. 405, 947-2013

OREGON:
5220 N.E. SANDY BLVD.
PORTLAND, OREGON 97213
TEL. 503, 282-9536

PENNSYLVANIA—EAST:
1921 S. 70TH ST.
PHILADELPHIA, PA. 19142
TEL. 215, 724-0999

PENNSYLVANIA—WEST:
257 RIVERVIEW AVE. W.
PITTSBURGH, PA. 15202
TEL. 412, 761-7648

TENNESSEE:
3614 LAMAR AVE.
MEMPHIS, TENN. 38118
TEL. 901, 365-1918

TEXAS—NORTH:
MOPAC LANE
LONGVIEW, TEX. 75601
TEL. 214, 753-4334

TEXAS—EAST:
4324-26 TELEPHONE RD.
HOUSTON, TEX. 77032
TEL. 713, 644-6793

Precision Tuner Service

is proud to announce the **GRAND OPENING**
of our new Service Centers in



BIRMINGHAM, ALA.

DETROIT, MICH.

MEMPHIS, TENN.

MIAMI, FLA.

ST. LOUIS, MO.

now you too get...



Fast **8** hr. Service!

\$10⁹⁵

1 YEAR GUARANTEE

ALL PTS BRANCHES are wholly owned subsidiaries of PTS ELECTRONICS, INC. (NO FRANCHISES!) and report directly to the Home Office in Bloomington, Indiana. Only this way can we guarantee the same quality - PRECISION TUNER SERVICE - that made PTS the leader in this field.

New 4th edition of our **TUNER REPLACEMENT PARTS CATALOG** now available (over 100 pages of tuner blow-ups, tuner - antenna coil - and shaft replacement guides 4th edition available for \$2.00)

**WE OFFER MORE.
SERVICE IS EVERYTHING
WITH US.
WE ARE DYNAMIC AND FAST.
TRUSTWORTHY.
YOU AND US - A
TRUE PARTNERSHIP.**

Color •Black & White •Transistor
•Tubes •Varactor •Detent UHF
All Makes

VHF, UHF	\$10.95
UV-COMBO	\$17.95
IF-SUBCHASSIS	12.50

Major parts and shipping
charged at cost.
(Dealer net!)

over 4000 exact tuner replace-
ments available for \$14.95 up
(new or rebuilt)

*PTS ELECTRONICS, INC. is recommended by more TV
manufacturers and overhauls more tuners than all
other tuner services combined!*

PTS-NUMBER ONE AND STILL TRYING HARDER!

(NOT A FRANCHISE COMPANY)

For More Details Circle (1) on Reply Card

Look what comes FREE with Sams Photofact® Easy Buy Plans!

In your business the right Photofact Set is almost as essential as the right tools. And Sams Easy Buy Time Payment Plan makes it easy to have the right set when you need it. Just use the Easy Buy Plan to start or to fill out your Photofact library and you'll not only save \$1.00 a set, you'll also get a bonus of FREE tools or equipment!

And there's no carrying charge! One dollar saved on each Photofact Set . . . bought on time without a carrying charge . . . plus FREE tools! It's an offer no TV or radio service shop can afford to pass by. Which of these five great Easy Buy Plans best fits your needs?

Easy Buy Plan #1. Any 60 Photofact Sets you need, for \$20 down, \$145 balance payable without carrying charge. Plus the \$6.15 Xcelite screwdriver/nutdriver set—free!

Easy Buy Plan #2. Any 180 Photofact Sets, for \$20 down, \$475 balance payable without carrying charge. Plus the \$12.40 Xcelite drive socket wrench kit—free!

Easy Buy Plan #3. Any 300 Photofact Sets for \$20 down, \$805 balance, payable without carrying charge. Plus your choice of the \$30 Xcelite #99SM service master tool—or a \$59.95 Craig #2624 portable cassette recorder!

Easy Buy Plan #4. Any 400 Photofact Sets for \$20 down, \$1080 balance payable without carrying charge, plus an \$89.95 Craig #4507 portable electronic calculator—free!

Easy Buy Plan #5. Any 500 Photofact Sets for \$20 down, \$1355 balance payable without carrying charge. Plus your choice of a \$125 Vaco tool luggage case or the \$169 ACT-R 10H/L/U scanner monitor—free!

Free tool/equipment offer expires June 30, 1974.

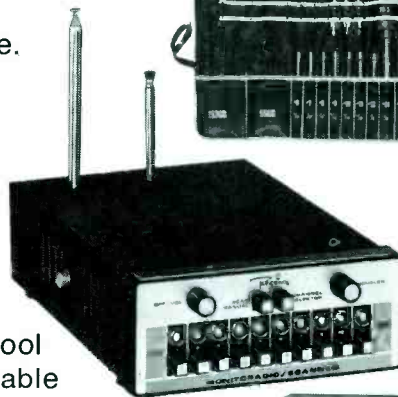
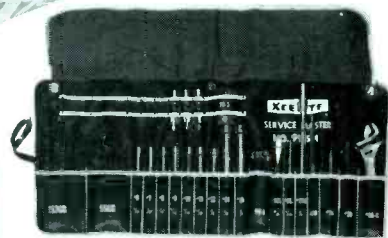

HOWARD W. SAMS & CO., INC.
4300 West 62nd Street, Indianapolis, Indiana 46206

ES-X74

I am interested in Easy Buy Plan # _____ Please send me a Photofact purchase contract.

Name _____

Company Name _____

Address _____

City _____ State _____ Zip _____

My Sams Distributor is _____

His Address _____

City _____ State _____ Zip _____

electronic scanner

news of the industry

A second generation of self-adjusting color TV receivers has been introduced in the 1975 line of GTE Sylvania. Continued is the IC "vertical countdown" feature that eliminates the vertical-hold control. Horizontal hold, color intensity, color hue, fine tuning, brightness, and contrast are all controlled automatically. 53 of the 63 color receivers have 100% solid-state chassis. Plug-in circuit boards with plug-in transistors are used. The entire new line of monochrome sets are now solid state.

Radio Shack has purchased 849,000 acres of property on the moon. The property was purchased for an undisclosed sum from the Oklahoma Science and Arts Foundation, Inc. and its subsidiary, the Kirkpatrick Planetarium. The Foundation received title to the moon after its annexation by the City Council of Oklahoma City in 1965. According to Bernie Elfman, Radio Shack's retail sales promotion manager, 100-acre parcels of lunar real estate will be awarded to store managers as a sales incentive. Although company spokesman say there are no immediate plans for opening a Radio Shack store on the moon, the company has been expanding rapidly.

General Electric is stressing the 100% solid-state chassis in color TV for 1975, but has retained some hybrids to meet retail price points. A number of new models feature the Custom Picture Control, by which brightness, contrast, and color intensity can be lowered or raised simultaneously without losing relationship to each other, reports **Home Furnishings Daily**.

A new "faston" color cathode ray tube, developed by Westinghouse Electric Corporation, produces a picture in four to six seconds after turn-on. The tube incorporates a newly designed cathode/heater assembly which enables fast heatup without shortening the life of the tube. A new cathode coating which substantially extends the life of conventional tubes is also being developed; the coating will be utilized in the "faston" design.

In an effort to keep color TV prices as high as possible while remaining competitive, **Magnavox has added an electronic tuning device and extended the 100% solid-state chassis** to its entire 1975 color TV line. The new STAR electronic tuning system permits the viewer to switch from any one station to any other without running through the entire dial sequence, and provides channel changes directly from VHF to UHF or vice versa. It is accompanied by a digital readout of the station number on the TV screen, according to **Home Furnishings Daily**.

The Admiral Corporation merger into Rockwell International took effect in April. Ross D. Siragusa, Jr., Admiral president, was named a director of Rockwell, reports **Radio and Television Weekly**.

(Continued on page 6)

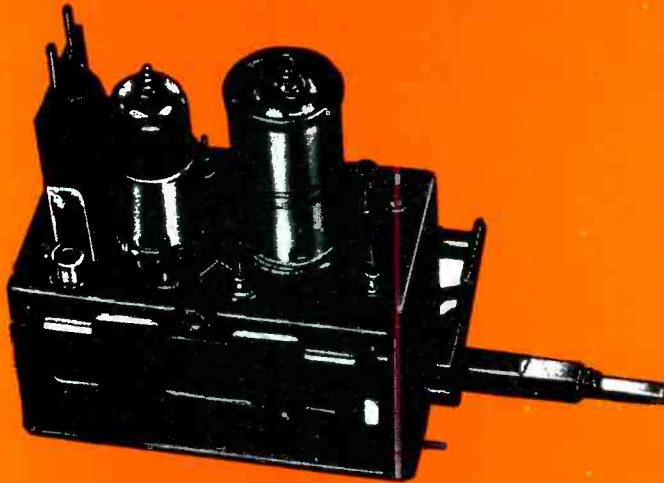

\$9.95

ALL PARTS INCLUDED
EXCEPT TUBES & TRANSISTORS

ONE YEAR GUARANTEE

TUNER SERVICE CORPORATION

PROVIDES YOU WITH A COMPLETE SERVICE FOR ALL YOUR TELEVISION TUNER REQUIREMENTS.

REPLACE

Universal Replacement Tuner **\$12.95** (In Canada \$15.95)
This price buys you a complete new tuner built specifically by **SARKES TARZIAN INC.** for this purpose.

All shafts have a maximum length of 10½" which can be cut to 1½".

Specify heater type parallel and series 450mA or 600mA.

REPAIR

VHF Or UHF Any Type **\$9.95.**
UHF/VHF Combo **\$15.00.**

In this price all parts are included, tubes, transistors, diodes, and nuvistors are charged extra. This price does not cover mutilated tuners.

Fast efficient service at our conveniently located service centers.

All tuners ultrasonically cleaned, repaired, realigned and air tested.

CUSTOMIZE

Customized tuners are available at a cost of only **\$15.95**; (with trade-in **\$13.95**) (In Canada \$17.95/\$15.95)

Send in your original tuner for comparison purposes.



HEADQUARTERS	BLOOMINGTON, INDIANA 47401	537 S. Walnut Street	Tel. 812-334-0411
ARIZONA	TUCSON, ARIZONA 85713	1528 So. 6th Street, P.O. Box 4534	Tel. 602-791-9243
CALIFORNIA	NORTH HOLLYWOOD, CALIF. 91601	10654 Magnolia Boulevard	Tel. 213-769-2720
	BURLINGAME, CALIF. 94010	1324 Marsten Road	Tel. 415-347-5728
	MODESTO, CALIF. 95351	123 Phoenix Avenue	Tel. 209-521-8051
FLORIDA	TAMPA, FLORIDA 33606	1505 Cypress Street	Tel. 813-253-0324
GEORGIA	ATLANTA, GEORGIA 30310	938 Gordon Street S.W.	Tel. 404-758-2232
ILLINOIS	CHAMPAIGNE, ILLINOIS 61820	405 East University Street	Tel. 217-356-6400
	CHICAGO, ILLINOIS 60621	737 West 55th Street	Tel. 312-873-5556-7
	SKOKIE, ILLINOIS 60076	5110 West Brown Street	Tel. 312-675-0230
INDIANA	HAMMOND, INDIANA 46323	6833 Grand Avenue	Tel. 219-845-2676
	INDIANAPOLIS, INDIANA 46204	817 North Pennsylvania St.	Tel. 317-632-3493
KENTUCKY	LOUISVILLE, KENTUCKY 40208	2920 Taylor Boulevard	Tel. 502-634-3334
LOUISIANA	SHREVEPORT, LOUISIANA 71104	3025 Highland Ave.	Tel. 318-861-7745
MARYLAND	BALTIMORE, MD. 21215	5505 Reisterstown Rd., P.O. Box 2624	Tel. 301-358-1186
MISSOURI	ST. LOUIS, MISSOURI 63132	10530 Page Avenue	Tel. 314-429-0633
NEVADA	LAS VEGAS, NEVADA 89102	1412 Western Ave. No. 1	Tel. 702-384-4235
NEW JERSEY	JERSEY CITY, NEW JERSEY 07307	547-49 Tonnes Avenue HWY 1&9	Tel. 201-792-3730
	TRENTON, NEW JERSEY 08638	904 N. Olden Ave.	Tel. 609-393-0999
OHIO	CINCINNATI, OHIO 45216	7450 Vine Street	Tel. 513-821-5080
	CLEVELAND, OHIO 44109	4597 Pearl Road	Tel. 216-741-2314
OREGON	PORTLAND, OREGON 97210	1732 N.W. 25th Avenue	Tel. 503-222-9059
TENNESSEE	GREENEVILLE, TENNESSEE 37743	1215 Snappa Ferry Road	Tel. 615-639-8451
	MEMPHIS, TENNESSEE 38111	3158 Barron Ave.	Tel. 901-458-2355
TEXAS	DALLAS, TEXAS 75218	11540 Garland Road	Tel. 214-327-8413
VIRGINIA	NORFOLK, VIRGINIA 23513	3295 Santos Street	Tel. 703-855-2518
CANADA	ST. LAURENT, MONTREAL, QUEBEC H4N-2L7	305 Decarie Blvd.	Tel. 514-748-8803

WATCH US GROW

FOR INFORMATION ON FRANCHISE, CONTACT HEADQUARTERS

For More Details Circle (5) on Reply Card

Inventories of color TV sets at factory and distributor levels are high and still climbing, but manufacturers are not concerned. Inventories as of May 3 at the factory level were 47% higher than during the same period in 1973; distributor stocks were about 13% higher. Manufacturers claim they are building sets at a relatively high rate as a hedge against further inflation in production costs, reports **Home Furnishings Daily**.

On May 3, **Teledyne Packard Bell** announced its plans to discontinue the production of home entertainment products. The phase-out of television and stereo manufacturing at its plants in Nogales, Mexico and Los Angeles, California will begin immediately. Packard Bell also announced that its retail dealers will continue to receive product support, parts availability and warranty service through Teledyne Service Company, which has 10 parts depots and 55 service branches located in major cities throughout the United States.

The Justice Department has virtually given up its attempts to force Motorola Inc. to halt the proposed sale of its home television receiver business to Matsushita Electrical Industry Co. of Japan. An article in the **Wall Street Journal** says the department last month won a 30-day postponement of the sale, during which time Motorola was ordered to seek alternative buyers. Inquiries were received from Zenith, Magnavox, and a former employee of Magnavox who represents a group of investors outside the electronics industry; however, the closing date of the agreement to sell Motorola to Matsushita remains scheduled for May 28. Senator Birch Bayh (D., Ind.) is convinced that if the sale goes through, the Japanese firm eventually will shift the operation overseas, reports **Home Furnishings Daily**.

The Consumer Product Safety Act of 1972 requires all potentially hazardous conditions existing in consumer products to be reported to the Consumer Product Safety Commission, Washington, D.C. 20207. Penalties are just as stiff for the retailer as for a manufacturer who knowingly fails to report a possible hazard in a whole line of sets.

Sony, RCA, and Zenith are developing home video playback systems. Sony has a video record and playback system using magnetic cards instead of discs or tapes. Zenith's optical video disc system features a 12-inch record which can conceivably retail for approximately the price of an audio disc and can offer up to 30 minutes of playing time. RCA showed its Selecta-Vision home video system to consumers in Indianapolis in a "not for sale" demonstration designed to test their reactions. There are no plans at present for commercial production of the systems, according to several articles in **Home Furnishings Daily**. □

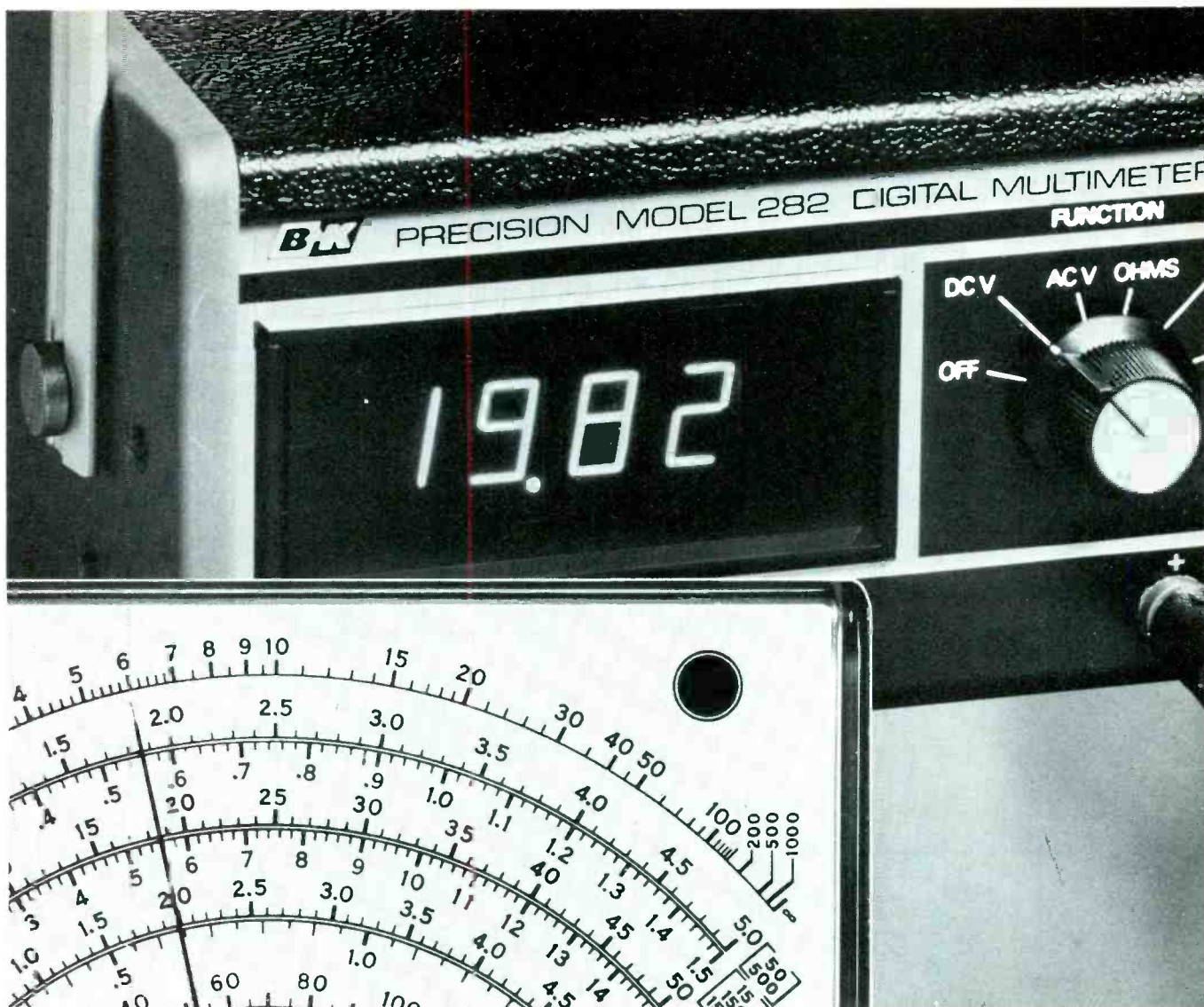

What's the Difference?

3-1/2 digit multimeter with 6 to 13 times the accuracy of a typical analog meter

The industry's most popular bench-type VOM, compared above to our Model 282 Digital Multimeter, has 3% full scale DC accuracy. On the 50-volt scale, that's an accuracy of ± 1.5 volts, or an accuracy of reading of 7.5% at about 20 volts. The 282's accuracy of reading is $0.5\% \pm 1$ least significant digit, or ± 0.11 volt. Divide those two figures—1.5 by 0.11—and you find that the 282 has 13.6 times the accuracy at that reading.

Even at readings close to 50 volts, where the analog multimeter is most accurate, Model 282 remains more than six times as accurate as the analog multimeter.

As for ease of reading . . . the picture above shows Model 282 and the analog meter full size. Put it where you'd normally set up your multimeter and see for

yourself how much more easily you can read the 282's bright digital display.

And there's more—automatic polarity, clear out-of-range indication, automatically positioned decimal point, 100% overrange capability, complete overload protection, 10 megohms input impedance and a three-position handle that doubles as a stand for tilt-up viewing. Plus a Model PR-21 probe with switchable 100K ohm isolation resistor to prevent capacitive loading while measuring DC in RF circuits.

And all for almost an analog price! Now in stock at your local distributor or write Dynascan.

**MODEL
282
\$200**



B&K PRODUCTS OF
DYNASCAN

1801 W. Belle Plaine Ave. • Chicago, IL 60613 • Phone (312) 327-7270

For More Details Circle (6) on Reply Card

Chassis—RCA CTC68 (CTC52)
PHOTOFACT—1378-2 (1211-3)

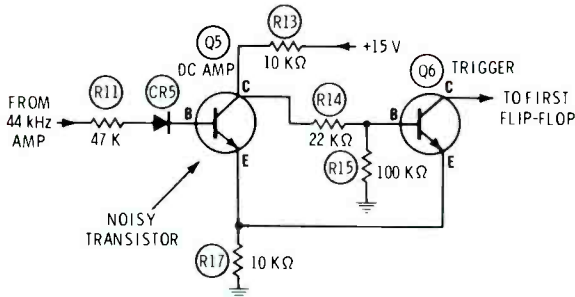

Symptom—Erratic on-off, or power on at all times
Cure—Check Q5 in remote, and replace if it is noisy

Chassis—RCA CTC48
PHOTOFACT—1300-2

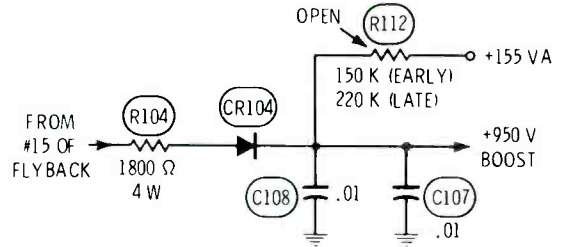

Symptom—Circuit breaker trips intermittently, and CRT screen voltage is excessive
Cure—Check R112, and replace if it is open

Chassis—RCA CTC48
PHOTOFACT—1300-2

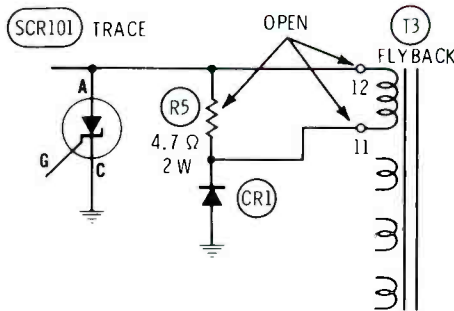

Symptom—No raster, R5 burns
Cure—Check for open circuit at terminals 11 and 12 of the flyback; also replace burned R5

Chassis—RCA KCS172 and KCS183
PHOTOFACT—1198-3 and 1286-1

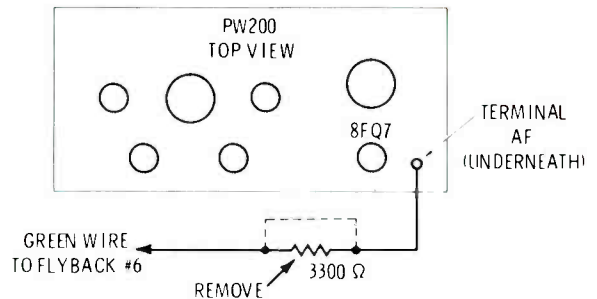

Symptom—Raster ringing at left edge of picture
Cure—Short across 3300-ohm resistor between stake AF and green wire which goes to pin 6 of the flyback

Chassis—RCA CTC54
PHOTOFACT—1301-3

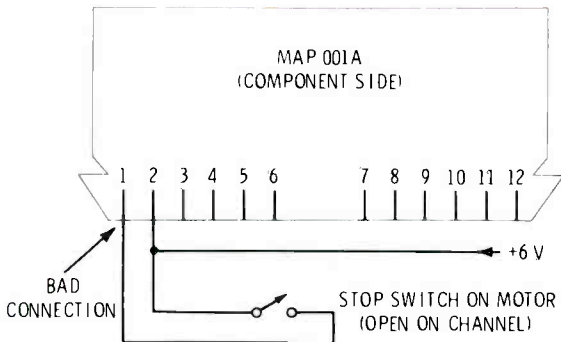

Symptom—Channels continuously following channel selection
Cure—Restore +6 volts to pin 1 of MAP001A; perhaps stop switch or a bad connection at pin 1

Chassis—RCA CTC52XAL
PHOTOFACT—1211-3

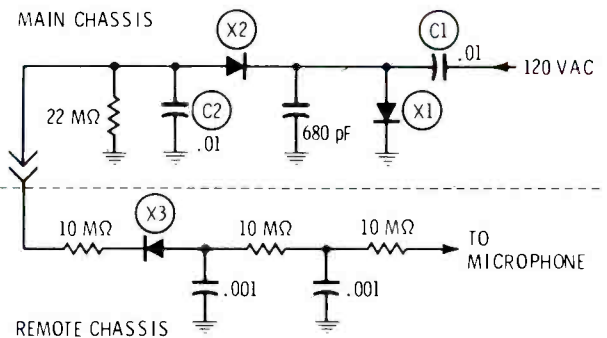

Symptom—No remote control operation
Cure—Check for loss of -150-volt supply to the remote microphone

reader's exchange

Needed: Two play heads number 563231. 900 ohm for Concertone model 605.

Clifton Jones
56 Morningside Drive
San Francisco, California 94132

Needed: Power transformer for Precision scope model ES-500A.

Glenn O. Tosten
Big Springs, Maryland 21712

Needed: Schematic with voltages, calibration and service notes for a General Electric oscilloscope model ST-2B.

Joseph Silver
A&B Electric Company
1883 East Main Street
Rochester, New York 14609

Needed: Schematic and other information for a Grunow Teledial radio receiver, model 1291.

Edward Juzumas
88-57 75th Street
Woodhaven, New York 11421

Needed: Manual and schematic for a Supreme Instrument model 546 scope.

Edward Schoener
P.O. Box 44
New Ringgold, Pennsylvania 17960

Needed: Schematic or any available data for Reverb-A-Sound X-505-R amplifier. Will buy or copy and return.

John J. Giuliano
304 Hicks Street
Brooklyn, New York 11201

Needed: A power-supply transformer for a CRO-2 Jackson scope.

A. J. Gallagher
West Side Radio-Television Service
513 West 10th Street
Erie, Pennsylvania 16502

Needed: Playback head for a Vista model 520 all-transistor tape recorder (5-inch open-reel type).

Gus A. Green
12692 Green Street
Boron, California 93516

Needed: Schematic and service information for model 705A signal generator, manufactured by Radio City Products Company of New York. Also need the decal that is on the front of the generator, as it is badly deteriorated.

Thomas deBrigard
5 Hamilton Avenue
Cranford, New Jersey 07016

(Continued on page 56)

**SOLID
STATE**

**Value
engineered for
total performance...
yet budget priced!**

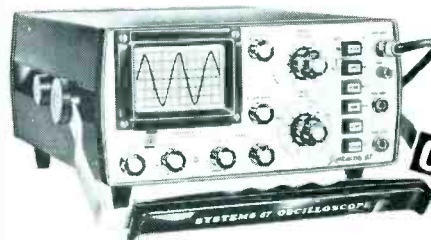

Systems 67
\$505.00

ONLY 9 lbs.

- DC to 10 MHz @ 10 mV • Triggered
- Solid State • Highly portable • Attractive in Systex Vinyl Aluminium finish • Easy grip handle serves as tilt stand • Printed circuit layout allows easy access to components
- Vectorscope facility • CRT display on 6 x 10 division graticule.

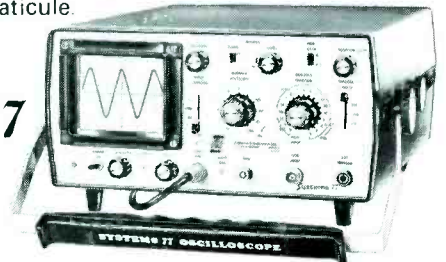

Systems 77
\$550.00

- DC to 15 MHz @ 10 mV • Triggered
- Solid State • Extremely portable
- Vectorscope facility • Attractive in Systex Vinyl Aluminium finish • Easy grip handle serves as tilt stand • CRT display on 8 x 10 division graticule • Useful for industry, academic institutions, service shops and maintenance.

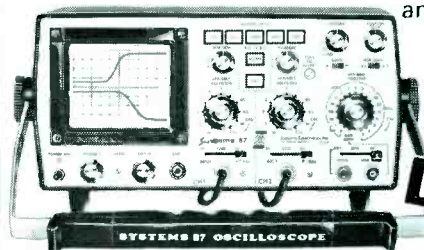

Systems 87
\$625.00

DUAL TRACE

- DC to 15 MHz @ 10 mV • Triggered
- Solid State • Easily portable • Vectorscope facility • Attractive in Systex Vinyl Aluminium finish • Easy grip handle serves as tilt stand
- CRT display on 8 x 10 division graticule.



Systems Electronics Inc.
OF CALIFORNIA

Makers of fine Oscilloscopes

9727 Inglewood Avenue, Inglewood, California 90301.
Tel: (213) 671-8231 • Telex: 67-7459 • Cable: 'Rectusa'

For More Details Circle (7) on Reply Card

FAST

COMPLETE SERVICE ON
ALL MAKES OF TV TUNERS

Maximum Time In Shop 24 Hrs.

(WE SHIP C.O.D.)
YOU PAY SHIPPING
\$9.95

(Warranty: One Full Year)

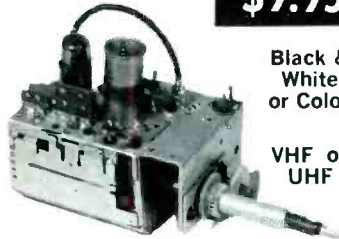

Black &
White
or Color

VHF or
UHF

UV Combo's \$16.50

Price includes all labor and parts except Tubes, Diodes & Transistors. If combo tuner needs only one unit repaired, disassemble and ship only defective unit. Otherwise there will be a charge for a combo tuner. When sending tuners for repair, remove mounting brackets, knobs, indicator dials, remote fine tuning arrangements and remote control drive units.

**WE UNCONDITIONALLY
GUARANTEE All Tuners
FOR ONE FULL YEAR**



All tuners are serviced by EXPERTLY TRAINED TECHNICIANS with years of experience in this specialized field. All tuners are ALIGNED TO MANUFACTURER'S SPECIFICATION on crystal controlled equipment and air checked on monitor before shipping to assure that tuner is operating properly.

**GEM CITY
TUNER SERVICE**

Box 6G Dabel Station
1621 Mardon Drive
Dayton, Ohio 45420

troubleshootingtips

Send in your helpful tips—we pay!

Small picture Packard Bell color model CRQ312 (Photofact 937-2)

The picture was narrow and not tall enough, usually a sign of an open filter capacitor in the power supply. Sure enough, C1A and C1B were defective. Unfortunately, new capacitors didn't help the size of the picture. New vertical and horizontal output tubes gave a slight increase of height and width, but not enough. High voltage was down to 12KV, with poor focus. Horizontal sync was critical, but vertical locking was normal. None of these symptoms pointed to any specific area, so I decided to analyze the voltages in the vertical and horizontal output stages.

After many fruitless DC voltage measurements, I noticed the cathode voltage of V11, the 15CW5 vertical output tube, was +40 instead of the normal +22. Also, this same voltage was applied to the suppressor grid of the horizontal output tube. To make a long story short, I found R122, a 1500 ohm glass-type resistor in the cathode

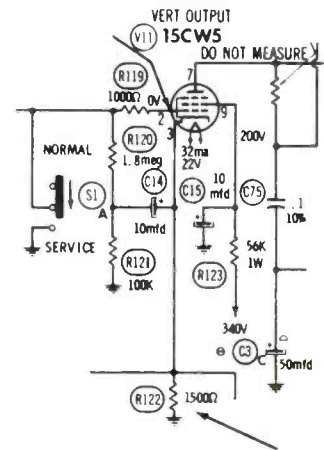

circuit of V11, to be completely open. A parallel path goes through another resistor and through the convergence circuit, so the vertical worked with partial height.

Replacement of the resistor gave normal width and height. A fast test for this resistor is to touch it with a finger. An open one will be cold, a normal resistor will be warm.

William Pokorny
Rice Lake, Wisconsin

Intermittent raster Sylvania E01 color chassis (Photofact 1251-3)

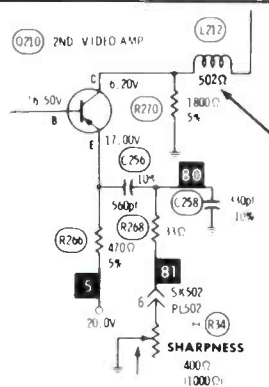

Every few hours, the raster would go black and would stay that way only two or three minutes before

becoming normal. Sound and high voltage remained during the black-outs. Because the trouble occurred so seldom, and could not be triggered by heat or cold, tapping, pressing or bending, I replaced all the video transistors and returned the set to the customer.

About ten days later, the customer reported intermittent operation again. This time I was determined to lick the dog. Bridging one video stage at a time using my dual-trace scope I alternately heated and cooled the components of each stage. Finally, these tests proved L212 to be intermittently open.

I replaced L212, and haven't heard from the customer since.

Bill Duaieme
Oconto, Wisconsin

Buzz in the sound
Packard Bell 98C19 color
chassis (Photofact 1019-1)

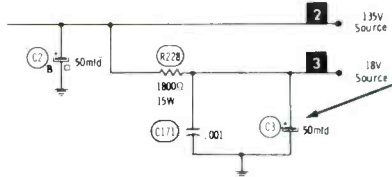

The only symptom was a buzz in the sound. I tried adjusting the quad coil, but without success. After many tests in the sound IF and demodulator stages, I started paralleling the filter capacitors.

A new 50 microfarad capacitor across C3 eliminated the buzz. C3 was open, and installation of a new one finished the repair.

Sargent's Distributing
 Company
 Bellflower, California

Blooming picture
Emerson 120883 color chassis
(Photofact 944-2)

When the TV receiver was brought to the shop, the picture was out of focus and much too large: a case of blooming. Evidently the picture tube was drawing too much current and loading down the high voltage.

DC voltage readings of the picture tube indicated the grids were too positive. Checking back from there revealed too little amplitude of blanking pulses at the cathodes of the -Y amplifiers.

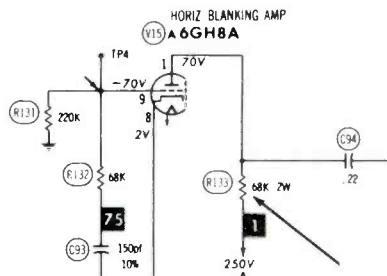

Additional tests showed that R133, a 68K 2-W resistor in the blanker plate circuit, had decreased to about 29K. A new resistor and readjustment of the gray-scale tracking completed the job.

Serge Thibodeau
 Quebec, Canada

THE ONLY COLOR SET YOU SHOULD TINKER WITH



It takes more than tools to be a TV service technician. It requires know-how, especially with a color TV set. Some "do-it-yourselfers" actually do more harm than good... and wind up paying more money for repairs or adjustments than they would have if they called their local TV technician at that first sign of trouble. So don't play with that color set. Tinkering can be dangerous as well as expensive. Call your independent TV technician for safety as well as satisfaction.

THIS MESSAGE WAS PREPARED BY SPRAGUE PRODUCTS COMPANY,
DISTRIBUTORS' SUPPLY SUBSIDIARY OF SPRAGUE ELECTRIC COMPANY, NORTH ADAMS, MASSACHUSETTS FOR
YOUR INDEPENDENT TV-RADIO SERVICE DEALER

PUT THIS BUSINESS-BUILDING TRAFFIC-STOPPER ON YOUR SHOP WALL OR IN YOUR WINDOW

See your Sprague Distributor for window-size blow-ups of this message. Or, send 25¢ to Sprague Products Co., 105 Marshall St., North Adams, Mass. 01247 to cover handling and mailing costs. Just ask for Poster RP-42.



THE BROAD-LINE PRODUCER OF ELECTRONIC PARTS

For More Details Circle (8) on Reply Card

Home TV reception direct from satellites!

By David A. Ferré

Engineer, RF Communications, Inc.

Can you imagine the elimination of all those huge TV transmitters and towers? And how about the possibility of receiving 80 programs just from one satellite? The techniques to do all this—and more—exist today!

Reception of television signals direct from satellite to viewer's homes is scheduled to start in Japan by 1977! Similar broadcasting services could become a reality in the United States by 1980. The technology to build and launch direct-broadcast satellites exists today. Any delays encountered in the US will be due to political, financial, and governmental considerations, not to technical problems. In fact, the Japanese direct-broadcast satellite is to be American-made by General Electric.

Why Broadcast from Space?

Many advantages can be gained by moving all TV broadcasting transmitters out into space. Some of these are:

- No more "ghosts". Because the receiving antenna points at a high angle, there is little chance of signal reflections, so pictures should be clearer;
- No fringe areas. Distances from the satellite to all points in the United States are nearly the same. Also, mountains or skyscrapers should present no barriers to signals coming almost straight down;
- More TV channels should be available. Theoretically, each satellite is capable of 80 TV channels;
- Each present TV channel could be re-allocated into 600 10-KHz radio channels, or 7,200 for all 12 VHF TV channels. This would relieve the overcrowding of the RF spectrum (a very serious problem).

Farther along in the article, we will give details of the gradual changeover to satellite reception, plus some guesses about future TV systems.

Satellites Today

Because the electronics information is of greater interest to us than the mechanical, we'll just assume that each satellite is in the correct orbit and position, and start from there.

A typical satellite link is illustrated in Figure 1. A transmitter on the ground beams the signal to the satellite (up-link). Electronic equipment in the satellite amplifies the signal, changes the frequency of the carrier, and transmits it back to another point on the earth (down-link). Up-link and down-link frequencies usually are different to prevent interference, because the same antenna might be used for



An engineer adjusts the orientation of a parabolic "dish" satellite-receiving antenna while watching a signal-strength meter. Experimental equipment manufactured by RF Communications, Inc.

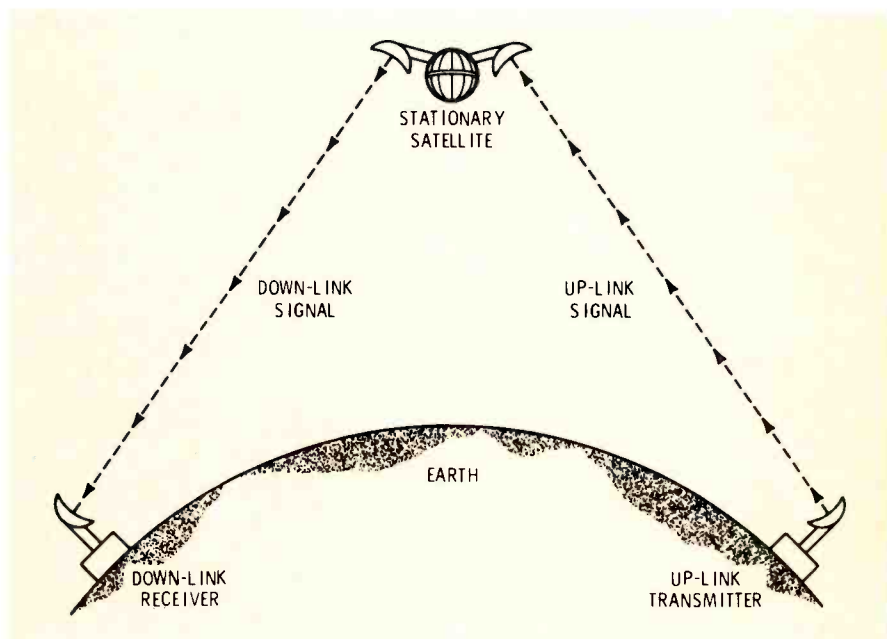

Fig. 1 Carriers with video and audio signals will be beamed by the up-link transmitters to the satellite. Frequencies of the carriers will be changed before the signals are sent back to earth. In practice, the transmitters and receivers probably would be nearer each other than shown. Also, there might be millions of receivers, or just a few which feed distribution systems, such as MATV or CATV.

Fig. 3 Correct beamwidth depends on the height of the satellite, and on the area of earth where reception is desired.

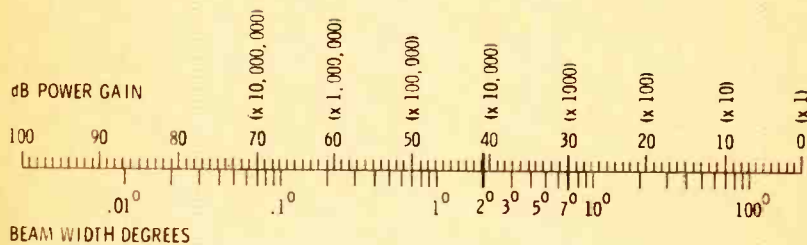
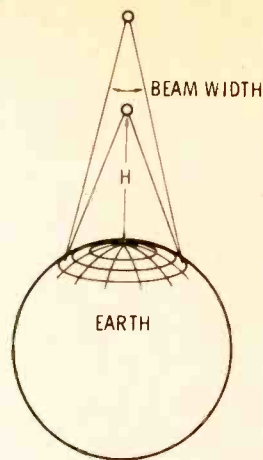

Fig. 2 Increased usable signal is obtained when the beamwidth is narrowed.

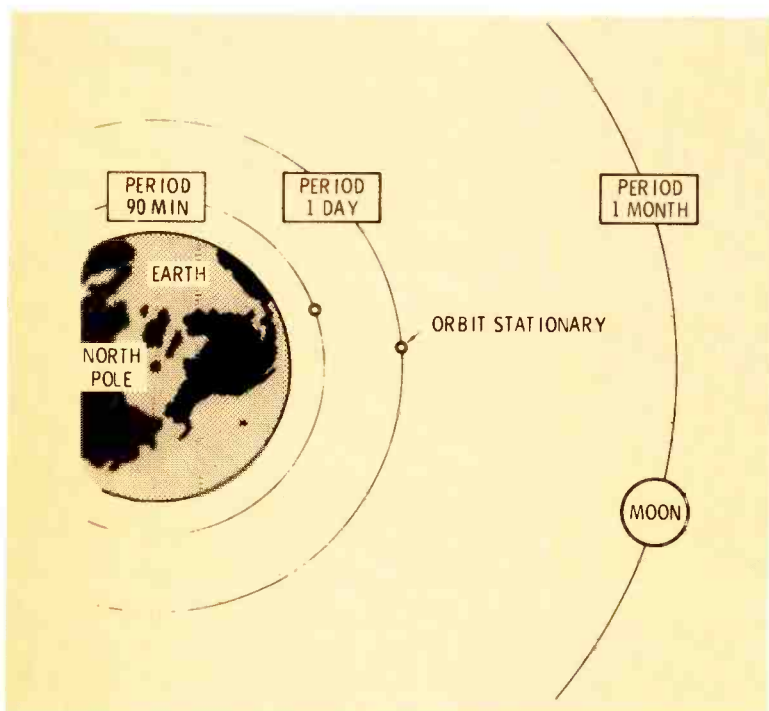

Fig. 4 In circular orbits, higher satellites require a longer revolution time. There is only one height (22,300 miles) at the equator which gives a synchronous orbit (apparently motionless, one revolution per 24 hours).

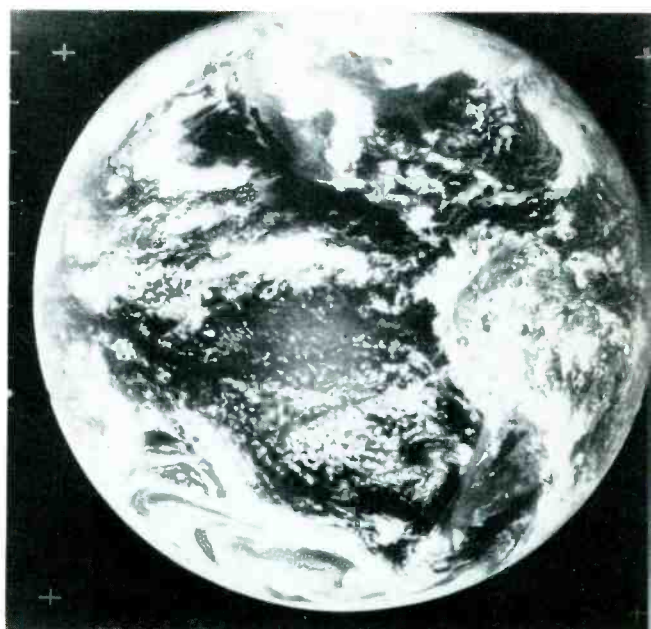

Fig. 5 View of the world taken from a NASA satellite at 95° west longitude above the equator. South America is on the right, with Mexico and the United States at the top center. The satellite was at the correct location for TV broadcasting direct to any area of the United States. (Courtesy of NASA)

both transmitting and receiving.

Today's satellites usually operate in the "S" band (1,500 to 5,200 MHz) part of the spectrum. It's probably unnecessary to say that the satellite must be completely motionless in space, and have its antennas perfectly oriented in relationship to the transmitting and receiving points on earth.

Orientation of the up-link signal path is less critical than the down-link path. That's because of the unlimited power possible in the up-link transmitter. The satellite oper-

ates from batteries charged by solar cells, so there are restrictions on the amount of down-link power.

Down-link transmitter power typically is 10 watts at present. To increase the effective-radiated power (ERP), the down-link antenna is made to be very directional (narrow beamwidth). Optimum beamwidth depends on the height of the satellite and the area on earth where coverage is desired. Figure 2 shows the power gain obtained by making the antenna more directional.

Let's assume we want to cover the Continental 48 states. Next, we need to know the altitude of the satellite. The higher the satellite, the narrower the beamwidth (Figure 3), and that's good. But, the distance is greater, which causes larger losses of the signal.

When mathematicians were calculating the optimum location and altitude for the satellite, they rapidly found that the higher the altitude, the more time required for one revolution around the earth. For example, the first astronauts

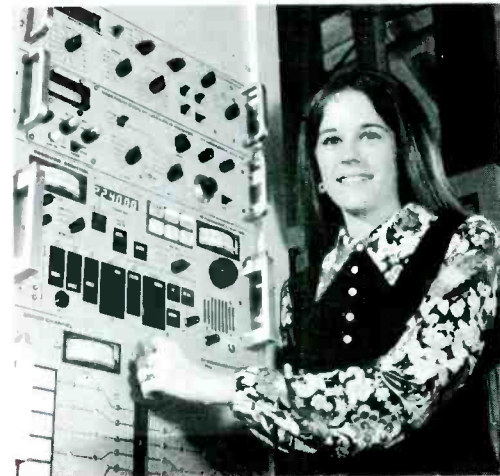
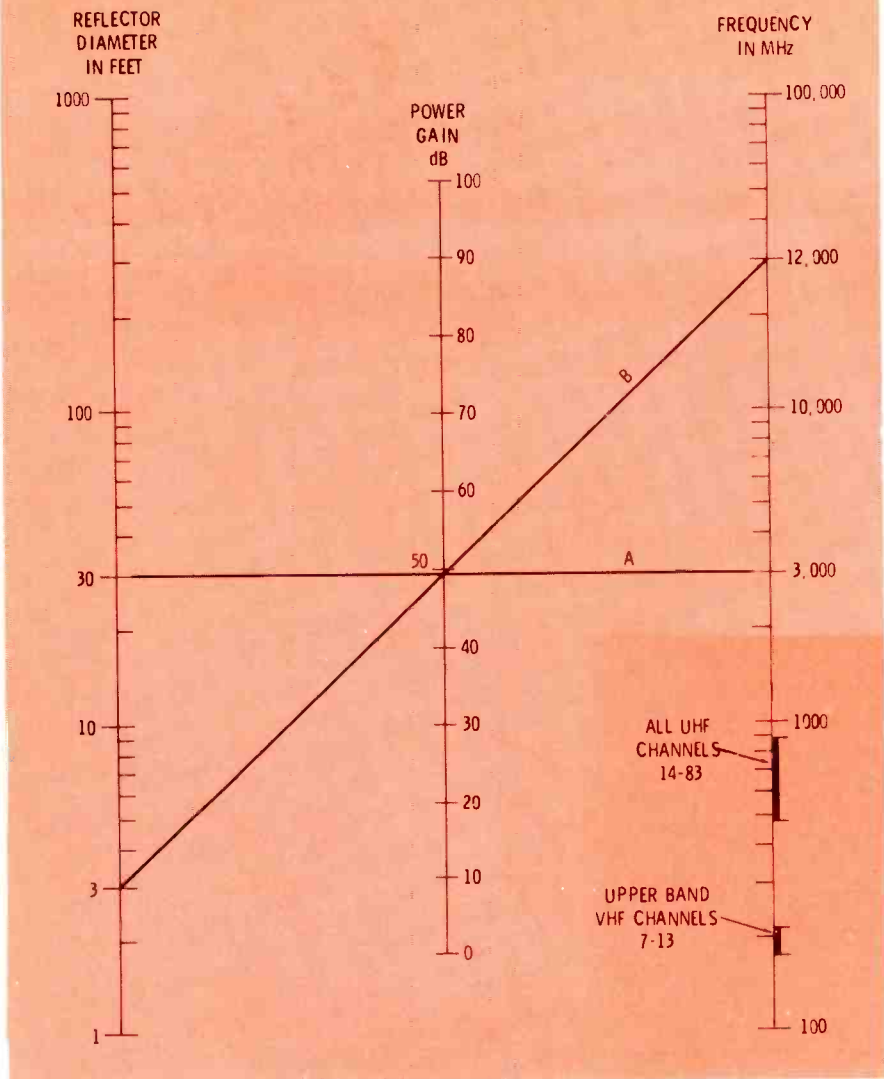

Satellite multifunctional receivers (MFR) process signals from down-converters. Signals from the down-converter to the MFR usually are in the 400-500 MHz range. However, frequency-logic circuits allow the actual frequency to be entered in receiver control.

(Courtesy of RF Communications, Inc.)

Fig. 6 Power gain of antennas depends on design, physical size, and the operating frequency. For 50 dB gain, a parabolic dish should be 30-feet in diameter for 3,000 MHz, but can be only 3-feet for 12,000 MHz.

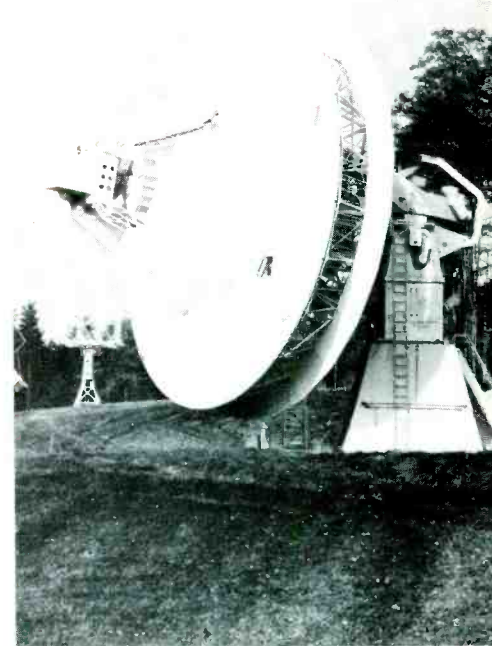

A 30-foot "S"-band system antenna and operating console at the Greenbelt, Maryland training facility of NASA. Seventeen similar systems also are in use around the world.

(Courtesy of NASA)

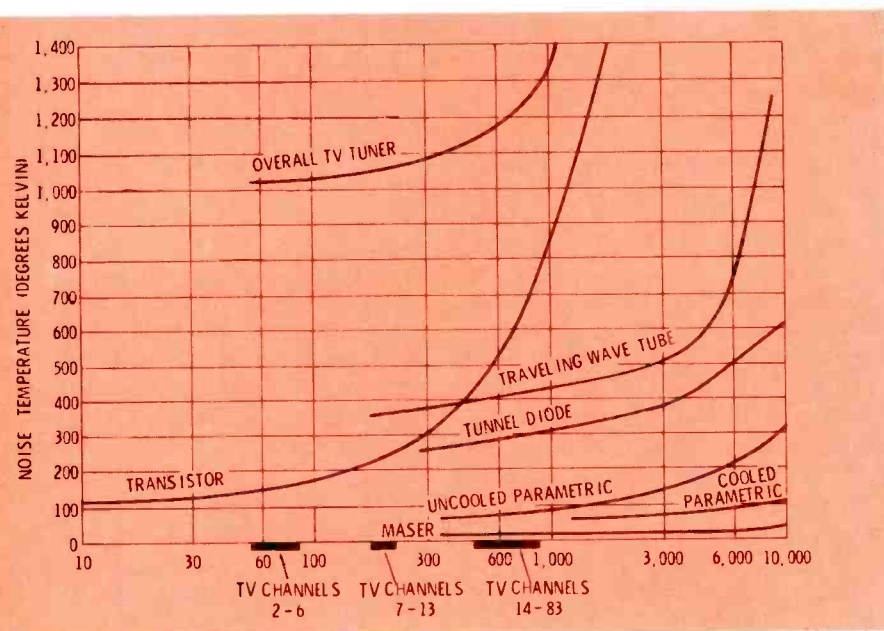

Fig. 7 In the space program, noise levels of equipment and devices are rated in degrees Kelvin. The chart shows transistors to have the most noise, and cooled masers to have the least at the frequencies of the "S" band.

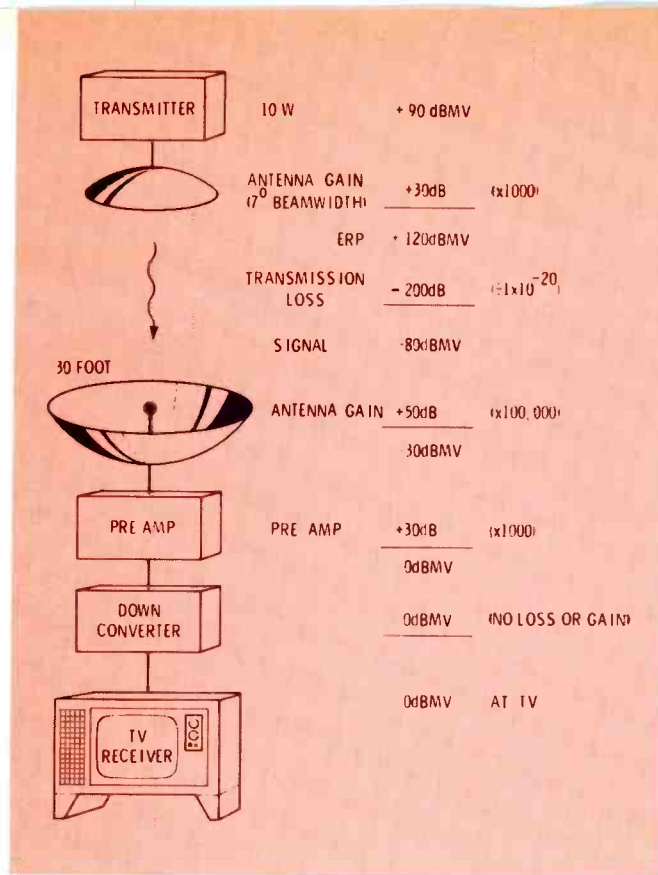

Fig. 8 This chart shows the levels of signal at each point of the present "S"-band satellite system. Both the antenna and pre-amp are extremely expensive, thus making the system not applicable for use by individuals.

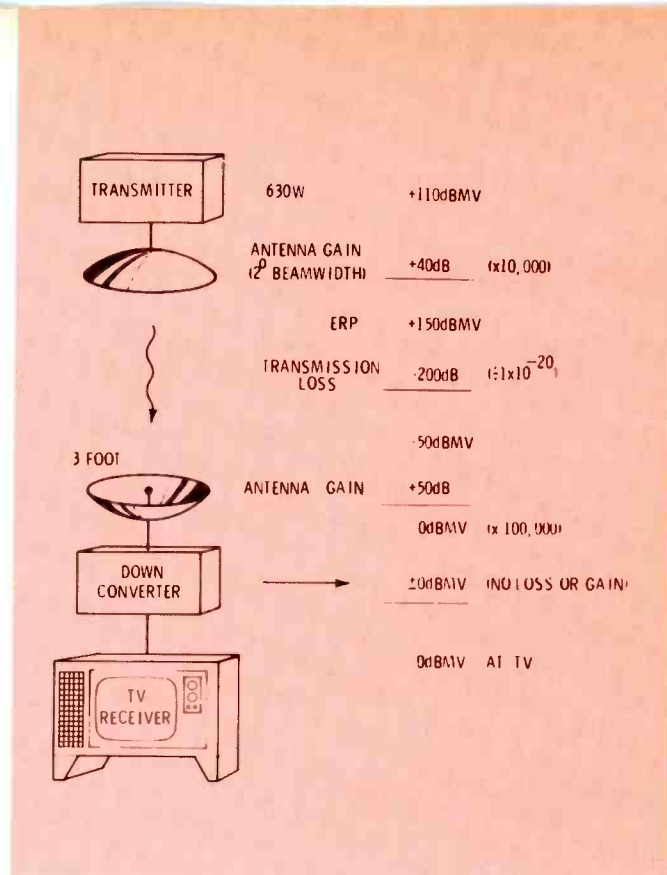

Fig. 9 The new Japanese satellite system will have a high-powered transmitter, which eliminates the need for a pre-amp at the receiving end. Also, the frequency is about 12,000 MHz, and this permits antennas of about 3-feet in diameter. Prices of receiving antenna systems should be low enough for individuals to install them on their own homes.

could circle the earth in 90 minutes; yet the moon takes 28 days to do the same thing. Figure 4 shows that between these two extremes, there's a possible orbit of exactly 24 hours.

If a satellite is placed in a 24-hour orbit and exactly over the equator, it would appear to us on earth to be stationary. This orbit is called geostationary or synchronous, and is the basis for all future TV satellite positions. The greatest advantage of a synchronous orbit is that the receiving antenna can be in a fixed position.

Pictures from weather satellites (Figure 5) all appear to have been taken by someone over the equator. Those satellites also are in synchronous equatorial orbits.

Beam-width calculation

Altitude for a synchronous orbit now is known to be 22,300 miles. Therefore, beamwidth for coverage of the 48 Continental states is 7°. The chart of Figure 2 shows the required antenna gain to be +30 dB. Antenna gain has multiplied the 10 watts of power by 1,000, so

the ERP is 10,000 watts.

Down-link equipment

After such a long trip, the down-link signal is extremely weak. Typically, the attenuation is about 200 dB. That means the power if received by a reference dipole antenna (unity gain) only would be .000,000,000,000,01 watt.

Obviously, processing and amplification of such a weak signal **must** be done by equipment that adds virtually no noise to it. First step is to use a high-gain antenna. Because of limitations in the pre-amplifier, +50 dB (X100,000) gain is needed. From Figure 6, we calculate that a down-link frequency of 3,000 MHz would require a 30-foot parabolic dish.

Next, the signal is amplified in a special low-noise pre-amplifier. Figure 7 gives a comparison of the internal noise of several types of amplification systems.

Rating the noise in terms of degrees Kelvin might be new to you. Most noise originates in ran-

dom electron movement caused by heat (thermal or Johnson noise). As the temperature is lowered, the random movement decreases (less noise). Finally at a certain temperature, all random movement ceases. This is called absolute zero, which is 0° Kelvin or C° plus 273.

Space scientists have agreed to refer to the noise of all devices in terms of degrees Kelvin. For example, in Figure 7, the equivalent temperature of the noise in a standard TV tuner at VHF frequencies is about 1,000°K.

Also from Figure 7, the device with the lowest noise is a maser amplifier. This amplifier is cooled to about 1°K by liquid helium, and can amplify very weak signals without adding any appreciable noise.

After the pre-amplifier, the 3,000 MHz signals are strong enough for the down-converter, which heterodynes the signals into the UHF band.

A review of the down-link gains and losses is shown in Figure 8.

The 0 dB reference is the TV standard of 1,000 microvolts at 75 ohms impedance, and it is called 0 dBmv.

As you can understand from the previous explanation, the receiving systems of today's satellites are quite complex. They require a huge 30-foot parabolic receiving dish and a helium-cooled maser pre-amplifier. Equipment of this size and expense is far beyond the scope of individuals (or even large cable systems). Fortunately, new technological developments have simplified these requirements.

Japanese Satellite System

The problem of the 30-foot receiving antenna was solved by changing from the "S" band (3,000 MHz) to the "Ku" band (12,000 MHz). In the new band, the same +50 dB power gain can be accomplished with only a 3-foot dish.

Next, the problem of the pre-amplifier was solved by increasing the transmitter power in the satellite, so the pre-amplifier was not needed. Transmitter power of the new satellite is 630 watts. Japan requires only a 2° beamwidth, so the transmitting antenna can give a gain of +40 dB (X10,000), making the ERP 6.3 million watts! Now the signal at the receiving dish is strong enough to go directly to the down-converter, eliminating the need for a pre-amplifier. This down-link system is reviewed in Figure 9.

Specs For American Satellites

Japan is fortunate in needing only a 2° beamwidth for coverage of the entire country. Because the United States requires a 7° beamwidth, an increase of 10 dB (X10) in power would be needed. At 12,000 MHz, that's a tremendous order, especially for battery-operated equipment!

Suggestions have been made to separate the 7° beamwidth into four 2° beams; in effect this would mean four separate transmitters. At this time, the final decision has not been made about which method will be used.

Launch Methods

Future TV satellites undoubtedly will be very expensive. It's too risky merely to send up rockets, hoping they'll work right and get the satellites into the correct orbits. The electronic circuits might break down and require a "service call". Also, if nuclear fuel is used to obtain the needed high power, new fuel will be required about once a year. Clearly, rockets are not the best answer.

All these problems have been solved by Congress approving funds for a space shuttle. Placing the satellites, delivering a technician for repairs, and fuel replacements will be handled from the shuttle.

What Happens Next?

It is difficult to imagine all the hundreds of VHF and UHF TV stations going out of business. You can bet the owners will fight hard and long to prevent or slow down the transformation to direct TV reception from satellites. Yet, eventually these conventional stations will be replaced by a national satellite and (probably) CATV network.

Present-day satellites have a signal bandwidth of 500 MHz. If that entire bandwidth were devoted entirely to 6-MHz TV channels, each satellite could handle 80 TV channels. And there is a possibility of a dozen or more satellites. This kind of competition would be too much for local stations to withstand.

However, the FCC is moving carefully and protectively to make the transition as smooth and painless as possible. Already they have passed the Domestic Satellite Docket allowing direct competition between satellites and standard microwave ground links.

Satellite And CATV?

CATV operators are likely to be in a favorable position. The cost of a down-link (which at first might be expensive) would be reasonable for a cable system, so they probably would be among the first to change to an all-satellite hookup.

What's more, CATV systems

would be the logical source for local advertisements, local news and special programs, which would be impractical for broadcast over the satellite system alone.

Free CATV?

I prophesy that CATV hook-ups eventually will be free. Advertising revenues should be sufficient for a normal return-on-investment. And the more hook-ups they have, the easier it should be to attract advertisers.

Instead of hundreds of TV stations scattered all over the nation with cable networks supplementing their coverage in many areas, the future might bring a few satellites to broadcast the national news and entertainment programs, and many free cable systems to add the local coverage and distribute the signals. Also in the former fringe areas, many individuals would install their own down-link systems and obtain national coverage equal to the best in the cities.

You don't believe it? Just wait a few years and see. □



Now you can get "XR" glass tubes in our economy line.

You know the EIA guidelines. Replace like with like.

That used to mean that all you could offer in "XR" glass tubes were the all-new, more expensive types.

Now, Sylvania has changed all that.

We've added 19 of the "XR" glass types to our Color Screen 85 economy line, and another 5 types to our medium price Color Bright 85® RE line. You can tell them by the

"V" designation in the type number. For example 23 VANP22. And of course, you've got all types in our Color Bright 85® "XR" new tube replacement line.

Three lines to offer. Three prices to offer.

That should eliminate a lot of your customer's inhibitions.

Electronic Components Group, GTE Sylvania, 100 First Avenue, Waltham, Mass. 02154.

Another first from the leader

GTE SYLVANIA



By John Rozsa



Which type of business is best for you?

Starting an electronic repair business requires attention to many time-consuming details that must be handled before you open your door for business the first day. In the rush of getting started, have you forgotten some basic considerations?

Whether you're the owner of a shop now, or a tech aspiring to future ownership, there are some decisions you need to know about the operating structure of your business. Is owning your own shop the best way to go? Or, would another type of structure work more to your advantage? Let's take a brief look at the types available to help you answer those questions.

There are three principal ways of operating your business: sole proprietorship; partnership; and corporation. It's important for you to know the benefits and responsibilities, advantages and disadvantages of each, because a bad choice might force your business to fail.

Sole Proprietorship

As the title implies, a sole proprietor is the only owner and boss. If you are the sole owner, you can contract for advertising, hire or fire employees, move to a different location, determine your store hours, or make up a flat-rate price list. All this, and more, can be done legally, and without any formalities.

Even if you have a bookkeeper, shop technician, or someone else to help you, it's still your show. You can be as aggressive or passive, cheerful or grumpy, modern or outdated as you wish without fear of rules or criticisms. You can make both personal and company decisions without having to consult or answer to anyone (except federal and state tax departments). **You**

have a unique kind of independence that's rare in our modern specialized world.

Your personal touch in dealing directly with your customers and distributors can enhance your reputation and prestige, and can be emotionally satisfying to you, also. Sounds good, but there's another side to the argument.

Disadvantages

Some of the disadvantages of operating as a sole proprietor are: when you're sick, you might be forced to close down the business until you recover; if you work alone, vacation time means a closed and profitless business; and banks or other lending institutions probably would place a lower limit on credit when only one person is responsible for repayment. Also, because you wear all hats, you probably are forced to spend many overtime hours with bookkeeping, tax forms, seminars, maintenance of shop and office, and other non-productive jobs; and there are fewer people you can trust and confide in, and who are genuinely interested in your welfare.

Financially, the most important drawback of proprietorship is that, in the event of business failure, your creditors can claim not only your business assets, but also your home, furniture and automobile. The independence you enjoy is bought at the price of **full** responsibility.

Partnership

Exchange verbal agreements with an acquaintance, friend, or relative, and you're in a legal partnership. Any number can be included. It sounds easy, and it is. However, the consequences could prove disastrous

unless the partnership is started on a firm, fair, and realistic foundation.

You and your partner (or partners) should have an attorney draw up a legal contract. List everything that's important to the successful operation of the business, such as:

- name and type of business;
- amount of capital investment from each partner;
- company titles, and the assignment of duties;
- salaries and when they are to be paid;
- distribution of profits (or losses);
- method of dividing assets, if the partnership is dissolved;
- length of time the partnership is to remain in force; and
- appointment of an arbitrator (perhaps the lawyer preparing the contract).

Advantages

As only one of several partners, you can take a vacation, stay home when you're ill, attend a convention, or take care of personal business with less pressure or restrictions.

The total investment in the business is larger, making it possible to spend more for equipment and stock, or to move into a more expensive business space. There are increased opportunities for loans or credit, when several people are responsible for repaying. Also, all abilities, salesmanship, business knowledge, and technical know-how are multiplied because more than one person is contributing.

A good team **can** work well together, stay in business making a profit, and achieve financial security for the common good.

Disadvantages

Several bosses could mean con-

flicting attitudes and ideas about how to operate the business. This might cause a less-efficient operation, with wasted time and energy because of disagreements.

If one of the partners dies, quits the company, or becomes disabled, the partnership should automatically dissolve. This might mean a temporary or permanent closing of the business.

Also, you are liable for commitments made by your partners; therefore, your personal assets are at stake.

These disadvantages make the selection of partners and the legal agreements of vital importance.

Corporation

Don't back off because you feel only giants like Xerox and IT&T should be corporations. They come in all sizes.

The most complicated form of business management is the corporation, the one most subject to governmental rules.

A corporation charter must be

obtained from the state. The charter defines and limits the authority of your organization. Most states require a minimum of three people to form a corporation. Each of the three must be of legal age, and at least one must be a citizen of the United States and live in the state granting the charter of incorporation. Forming a corporation usually requires the assistance of a lawyer.

Advantages

Your personal assets cannot legally be used to satisfy corporate debts. Bankruptcy, law suits, or other liabilities can claim only your initial investment. Undoubtedly, this is the chief advantage of operating your business as a corporation.

Another advantage is that the stockholders usually are inspired to make the business prosper. For that reason, some stock often is sold to employees. When they share ownership, they are more concerned

about making the operation more efficient and profitable, and probably take better care of equipment and property. These things are vital factors in maintaining peak efficiency of the business.

Disadvantages

Formation of a corporation involves planning, time, patience, and money. Extra fees must be paid, and a lawyer will be needed when you do business outside your state.

Taxation is double. First, profits of the corporation are taxed. Then the profit you make from stock ownership is taxed again, because it is your personal income.

Summary

Only **you** can decide whether a sole proprietorship, partnership, or corporation form of business structure would operate in your best interest. Each form has advantages, and each also has drawbacks and limitations. Study both sides carefully, then choose wisely. □

When is an exact replacement not an exact replacement?

When it's an **improved** exact replacement flyback or yoke from **STANCOR**.

Here's why:

- Not designed with every mil of cost reduction in mind.
- Performance and reliability are of prime importance. If more insulation or better materials are indicated, Stancor uses them regardless of cost.
- Exact replacements mechanically.
- No modifications required to install.
- Check Stancor's prices — you'll be glad you did.
- You get more for your money with Stancor.

For your improved replacement flybacks and yokes see your independent electronic parts distributor.



ESSEX INTERNATIONAL, INC., CONTROLS DIVISION 3501 W. Addison Street, Chicago, Illinois 60618

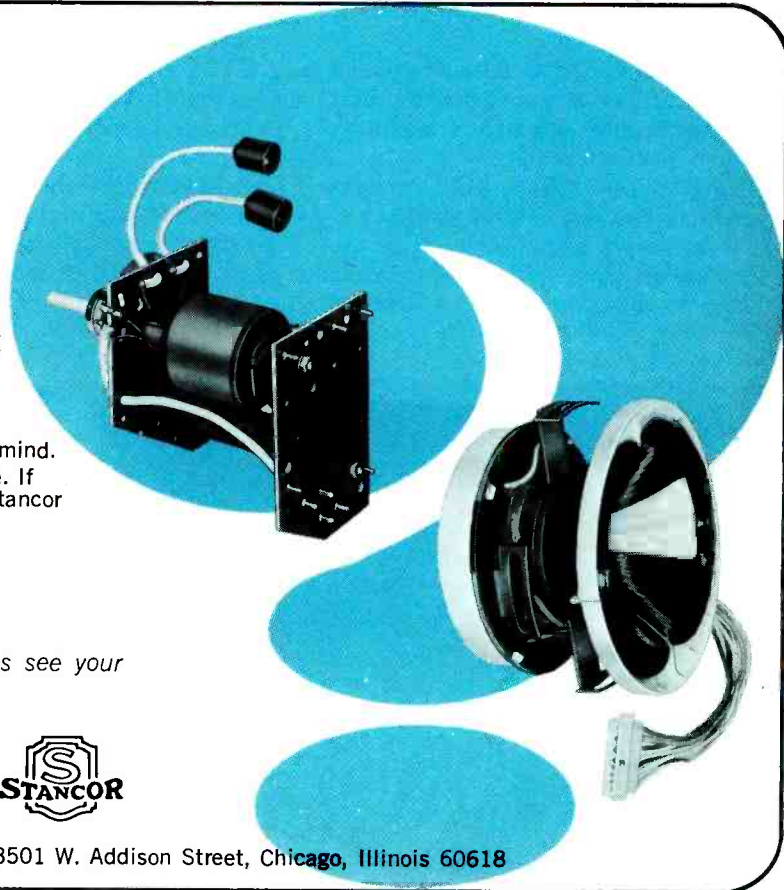

For More Details Circle (9) on Reply Card

MOTOROLA AGC PROBLEMS... Old and New part 1

By Henry V. Golden, CET



Background facts about AGC, and case histories of AGC failures in older Motorola color TV's make up this article. Next month, AGC problems of Motorola Quasar sets are covered.

All Automatic Gain Control (AGC) systems in TV receivers should accomplish these things:

- provide about the same contrast from either weak or strong signals.
- prevent overload of any tuner or IF stage.
- allocate the AGC voltages applied to RF and IF stages to give the best signal-to-noise ratio (minimize snow in the picture).

Remember that AGC always **reduces** the gain from maximum. Some simple but effective tests are based on this fact. Next, always keep in mind that all AGC circuits

used in color TV receivers have been closed-loop systems (Figure 1). That is, the amplitude of signal at some point in the system produces DC voltages which are used to reduce the gain of the stages furnishing the gain.

No closed-loop system can provide perfect regulation. Obviously, if the contrast always was the same, the AGC voltages would be the same, and that's impossible. In practice, more AGC voltage is developed with stronger signals. Analysis of the DC voltages is one of the prime tests for locating AGC defects.

One more thing about closed-loop circuits: a defect anywhere in the loop upsets voltages and waveforms everywhere. It's often desirable to break the loop and insert a test voltage or signal to defeat this effect.

Although the following case histories are about Motorola TS-914 and TS-918 chassis, many of the conclusions also apply to other makes and models.

Overload And Poor Convergence

Another technician brought to my shop a chassis he had diagnosed as having AGC trouble. The first thing I did was to try it on several

different signal strengths. A strong signal produced a black and overloaded picture, with hum in the sound, and picture bending (see Figure 2). With the antenna clothespin clipped around the insulation of the lead to the tuner, I found a snowy, but stable, picture. This indicated a loss of AGC. One more step confirmed the diagnosis: with antenna removed and set turned to a channel with no signal, the snow was normal in both quality and quantity.

The reason for these tests was to eliminate the possibility that the overload was caused by low tuner or IF gain. Low gain might stop all AGC voltages, but permit the mixer stage in the tuner to overload.

Figure 3 shows the AGC keying circuit of the TS-918A chassis.

Tube-type AGC

Briefly, here's how this AGC keyer stage works:

- Positive-going video is applied to the control grid through R88 and R87. Stronger signals produce more video and a higher positive voltage at the grid.
- The cathode voltage is clamped fairly well by the AGC control and its resistors. Adjustment of the control sets the contrast desired.

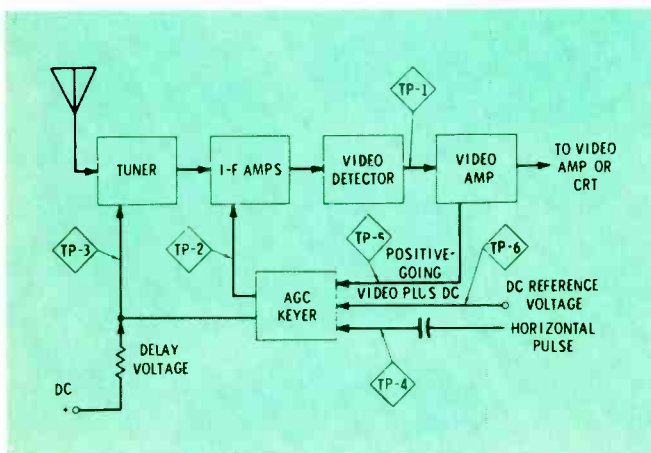

Fig. 1. Block diagram showing the closed loop of an AGC system typical of those used in all-tube circuits.

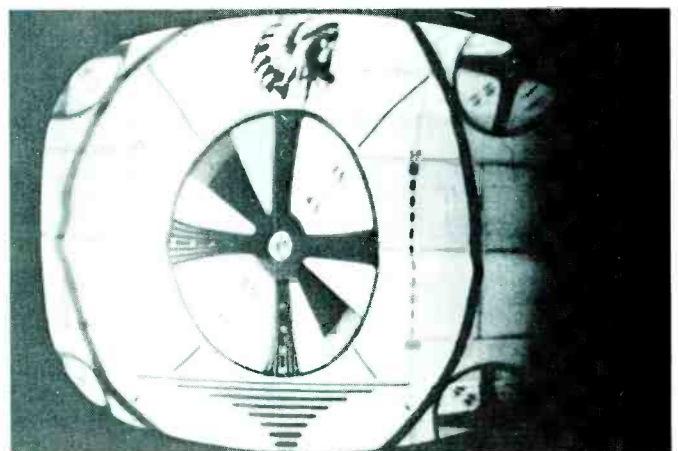

Fig. 2 A dark picture with horizontal bending is produced by insufficient AGC.

4 GOOD REASONS WHY YOU SHOULD BUY YOUR VOM FROM "THE BIG T"

1 TUCKER SELLS THE WORLD'S FINEST VOM - The Weston 660 series VOM are completely drop-proofed, custom ruggedized with self-storing carrying handle, pluggable circuit boards, external calibration and the highest quality components. Six models to choose from, all temperature compensated.



MODEL 660

2 YOU CAN TRADE-UP at a later date - or use your surplus instruments as trade-ins.

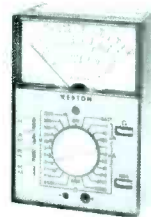

Model 666 VOM Solid-state circuit tester designed specifically for semiconductor circuit trouble shooting.

3 IT'S EASY. At Tucker one letter or phone call (on our special toll-free number) allows you to complete the deal. You can use your Bank Americard, Master Charge or American Express. Tucker will ship on P.O.'s, M.O., checks or COD.



4 IT'S SAFE. If for any reason you change your mind within 30 days, return your purchase and get your money back. This guarantee does not affect the normal WESTON guarantee of quality.



DC HIGH-VOLTAGE PROBE extends voltage range as high as 50KV. OPTIONAL \$23.75

OPTIONS

- Protective meter flap\$4.50
- Leather Carrying Case\$19.50



RF PROBE allows measurements to 50 MHz. OPTIONAL \$19.50

RANGES FOR 660, 661, 662, 663: DC Millivolts 0-250; AC/DC volts 0-2, 5/10/50/250/500/1000/5000; VAC output 0-2.5/10/50 and 250; DC microamps 0-50; DC Milliamps 0-1/10/100/500; DC Amps 0-10; Ohms Rx1 (0-2K) 20Ω center, Rx10 (0-20K) 200Ω center, Rx100 (0-200K) 2000Ω center, Rx1000 (0-2 Meg) 20KΩ center and Rx10K (0-20 Meg) 200KΩ center; dB scales -10 to +10/+2 to +22/+16 to +36/+30 to +50/+36 to +56,

PRICES: 660 (2% DC & 3% AC accuracy)	\$ 68.00
661 (1% DC & 2% AC accuracy)	\$ 76.50
662 (overload protection version of 660)	\$101.50
663 (overload protection version of 661)	\$110.00
666 (VOM solid state circuit tester)	\$139.00

Send your Check, M.O., Bank Americard No., Master Charge No., American Express No. to the address below. Add \$2.75 for shipping. Residents of California, New Jersey, Illinois and Texas add 5% sales tax. Call or write for your Free Weston 660 series brochure.



TUCKER
ELECTRONICS · COMPANY

P.O. Box No. 1050
Garland, Texas 75040

FOR RUSH ORDERS CALL TOLL-FREE 800-527-4642 (In Texas call 214-348-8800)

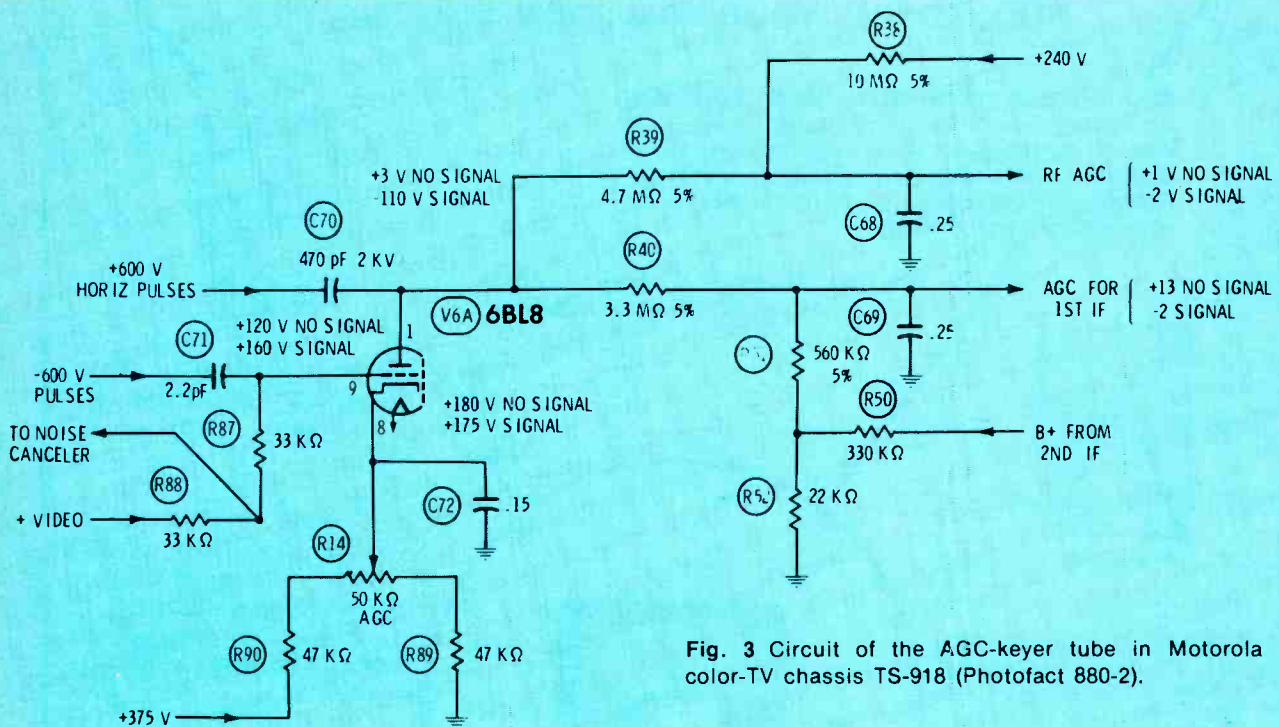

Fig. 3 Circuit of the AGC-keyer tube in Motorola color-TV chassis TS-918 (Photofact 880-2).

Fig. 4 Horizontal pulses from windings of T4 flyback transformer are used for AGC, convergence, color killer, burst keying, and others.

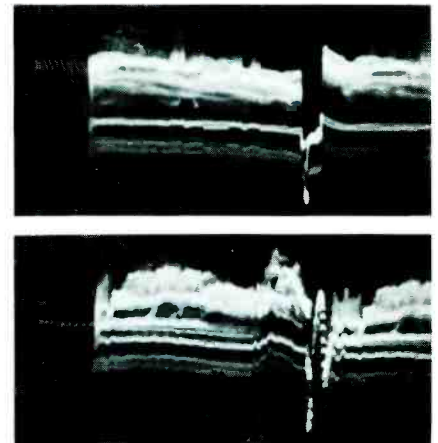
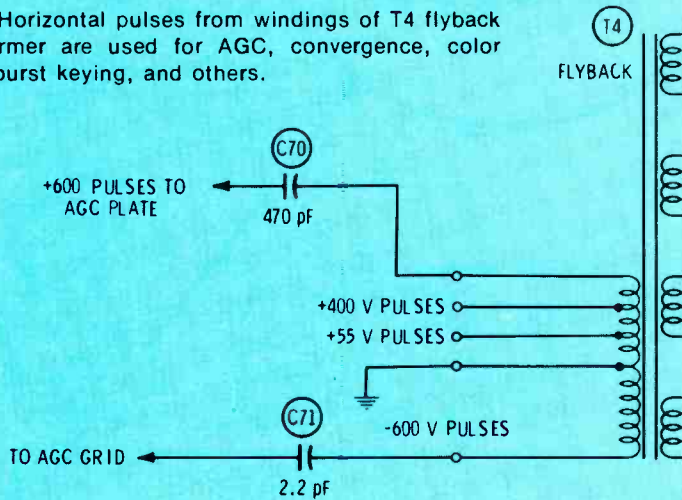

Fig. 5 Top waveform is the normal one at the delay line (scope vertical rate), and the bottom one is the video when the AGC capacitor opened.

- Without a signal, the keyer tube is biased to cutoff. Stronger signals reduce the bias, permitting more tube conduction.
- Reduced bias permits the tube to rectify the positive-going 600-volt p-p horizontal pulses brought from the flyback through C70 to the plate. This rectification might produce a negative DC voltage of more than 100 volts on strong signals.
- When there's no signal, a small positive voltage (from R50 and R52)

- must be applied to the grid of the 1st IF. That's necessary because the large-value cathode resistor produces around +15 volts. With +13 at the grid, the true bias is -2 volts, which gives maximum gain.
- With signal, the AGC voltage at the IF grid is slightly negative, giving around -6 volts of total bias, and reducing the gain.
- B+ brought in through R38 cancels part of the negative voltage for the RF tube. This reduces the

snow on moderate-strength signals. Strong signals cause the RF AGC to go negative, reducing the gain.

- Don't forget that the IF stages not controlled by AGC, the video detector, and the video stage which drives the grid of the AGC keyer all are part of the closed loop. Troubles there can simulate true AGC troubles.

Clamping the AGC

One test that many technicians

prize highly is to connect an external adjustable negative bias supply to the IF AGC point (C69 in Figure 2). In many cases, this is very helpful in eliminating the overload and pointing to a loss of all AGC. However, you can go wrong if a non-typical bias is required. For example, suppose the model you're working on usually has -12 volts, but -4 makes the set work okay on local channels. That's a sure sign more is needed than a simple AGC repair; perhaps the tuner or IF's have a loss of gain.

The TS-918 has such a high first-IF cathode voltage that a good, quickie test is just to ground the AGC at C69. I grounded it, and most of the overload was gone.

All the tests pointed to a loss of AGC voltage as the cause of the overload and instability. But why was the AGC missing?

Testing the keyer

Another fast test is to force the keyer into full conduction and measure the negative voltage at the plate. To do this, I shorted grid (pin 9) and cathode (pin 8) together with a screwdriver, giving zero bias. In this circuit, the DC plate voltage should have been about -200 volts.

I measured -30, proving that the keyer was conducting but not nearly enough. (If there had been **no** negative voltage, the horizontal pulses might have been missing, or the cathode-to-ground circuit could have been open.)

During previous repairs, I had wondered about the function of C71 and the large negative-going horizontal pulses there. Apparently the capacitor is supposed to bring in a small amount of the negative pulses which at the grid cancel an equally-small amplitude of positive pulses coming from the plate through the internal tube capacitance. Once as a test, I disconnected the capacitor, but noticed no change of symptoms or performance. Just to be sure this time, I tried a new one, but there was no improvement.

Any connection with poor convergence?

The next step logically should have been measuring the amplitude of pulses at the plate of the keyer. Then I remembered the poor horizontal convergence. Figure 4 shows the pulse windings of the flyback; the +400 volt pulses go to the convergence circuit.

Tracing the wiring of the flyback,

I found someone had reversed the wires going to the +600 and +400 terminals. This had ruined the performance of both the AGC and convergence.

Moral

There is a lesson here for all of us: don't take anything for granted. Check it for yourself, especially if repairs have been done previously.

Poor Picture, Poor Locking

Another chassis with suspected AGC troubles was brought in for my help. I was in a hurry, and didn't do all the quick tests I have recommended to you. Instead, I connected the bias supply, and found the locking improved, but a picture of low contrast and mediocre bandwidth. At the cathode of the video cathode follower, I measured less than half the normal amplitude of video.

These symptoms led me to believe the video detector diode might be leaky, and I replaced it, but without any change in performance.

After many other unproductive tests, and in desperation, I started replacing tubes. When the third IF tube was replaced, the gain jumped up to normal, and the AGC worked

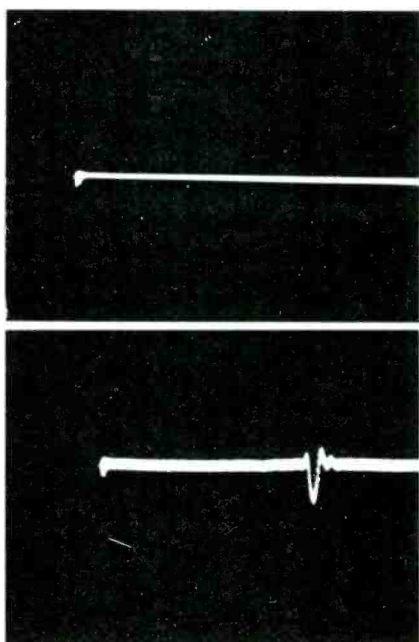

Fig. 6 Top waveform shows the normal absence of waveform at C69, the IF AGC source. Bottom waveform (scope vertical rate) shows the pulses there when C69 is opened.

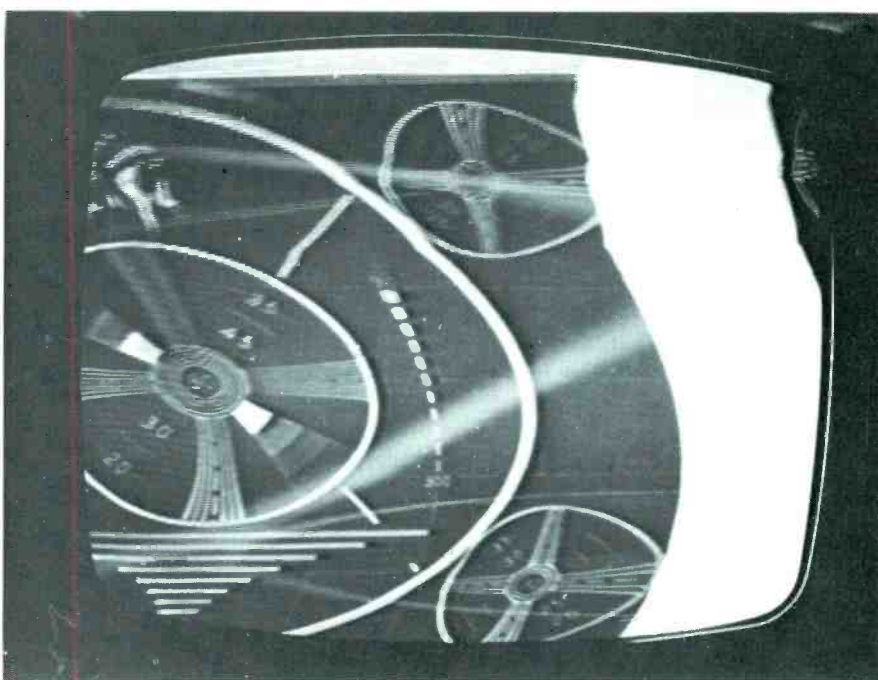

Fig. 7 Appearance of a "negative" picture; black and white are reversed. Usually there is no locking, because the sync pulses also are reversed in polarity.

okay, as well. **The lack of snow off channel would have alerted me to weak gain, if I had observed it.**

Sync Or AGC?

The most serious complaint was that the vertical would not stay locked at times. In addition, the picture had a tendency towards horizontal pulling when the vertical locking was critical. These are symptoms that might be caused by AGC troubles, sync separator defects, or open filters.

To make the situation worse, the symptoms would appear only a few short times each hour, and a scope probe touched almost anywhere would heal the defect.

I permanently connected the scope to the input of the delay line (a convenient test point for video waveforms), and worked on other sets while letting this one cook.

Finally, the scope showed a disturbance around the vertical sync pulses (Figure 5). At the same time the vertical rolled. Over the years, I have found many open AGC bypass capacitors which gave these same symptoms. But, even if that were the problem, connecting a meter or scope almost anywhere brought back normal operation.

So, again I connected the scope and left it attached, this time at C69 (Figure 3). When the vertical rolled next time, the waveform of Figure 6 showed on the scope screen. This proved C69 intermittently was opening, and installation of a new one solved all the problems.

Incidentally, the change of waveforms and the symptoms seen on the picture tube when the AGC capacitor is open are more pronounced in this model than in most others. Probably the reason is the very high amplitude of pulses applied to the plate of the AGC keyer tube. When the AGC filter capacitor opens, horizontal pulses are not filtered out, and they change the video gain mainly during the vertical retrace interval.

In addition, the pulses interfere somewhat with the amplitude of horizontal sync pulses in the video signal, upsetting the sync separator, which degrades the horizontal sync and causes picture pulling.

Negative Pictures

There are just two common causes of a negative picture (Figure 7). One is overload of a certain kind, and the other is a video-detector diode wired in with reversed polarity (usually by the technician who previously worked on the set).

Fortunately, there is a real easy way to tell which is the source. Just check the polarity of the DC voltage coming from the video detector. A reversed diode always gives a reversed-polarity voltage. If the anode is connected to the video amplifier, the output is negative DC with negative-going video. Or if the output is from the cathode, it is positive.

There's only one precaution. In these Motorola chassis, the video detector is not returned to ground, but is connected approximately from the grid of the video/chroma amp tube to cathode. The cathode is positive; therefore, the video-detector voltage would appear to be positive if measured to ground. The correct way is to measure from the grid of V4A to the junction of R62 and R61 (Figure 8).

A quick VTVM test showed the grid was negative relative to the cathode, and proved the diode had the correct polarity. Yet the video waveform there was somewhat clipped and positive-going.

Check stage-by-stage

The best method of finding the stage where a defect causing a negative picture occurs is to use a detector-type probe on your scope, and examine the waveforms starting at the last IF stage and continuing back to the output of the tuner. (The signal becomes too weak to measure in the tuner.)

In this case, the waveform was reversed in polarity (from what the probe should give) even at the tuner output. Although new tubes had been tried in the tuner, I installed new ones anyway. Surprisingly, this cured the negative picture. When I tried to insert the original 6KZ8 tube into the tube-tester socket, I found the converter cathode (pin 3) prong was bent over at right angles. It could not have been making contact.

Evidently overload in the tuner was the cause of the negative picture, although I can't explain how it was possible.

Erratic Video

The picture was overpeaked and had little contrast. IF AGC at C69 was varying wildly around +5 volts. When I scoped the grid signal of the 1st video amp (V4A), I found an undulating video signal of about 25% the normal amplitude.

I clamped the AGC using a bias supply, and this stopped the varying video. However, the picture only could be brought up to low contrast before overload started. Although the symptoms might have indicated AGC troubles, the clamping test proved the trouble to originate elsewhere.

Because the quality of the video was poor at the grid of the first video tube, I decided to check the components of the video detector.

One fast test of a video detector is to turn off the power and measure the resistance across the output of the detector. In this case, that was between grid and cathode of V4A. The idea is that an ohmmeter test of one polarity of the test leads should cause diode conduction and give a low reading. The opposite polarity reverse biases the diode, giving a reading only of the detector load resistor.

Figure 8 shows two paralleled detector load resistors, one 12K and one 6.8K ohms. The calculated resistance is slightly above 4K.

When I measured grid to cathode, I found the same approximate 4K reading using either polarity of the test leads. This was proof the diode (or another component near it in the circuit) was open. Several ohmmeter measurements later I found an open circuit in L8.

The open seemed to be near the center of the peaking coil, and the internal capacitance allowed some video to leak through. But the bandwidth was disturbed, and there was no DC component to activate the AGC operation. As a test, I jumpered the coil, and obtained a normal picture.

Other possible defects

If both readings had been less

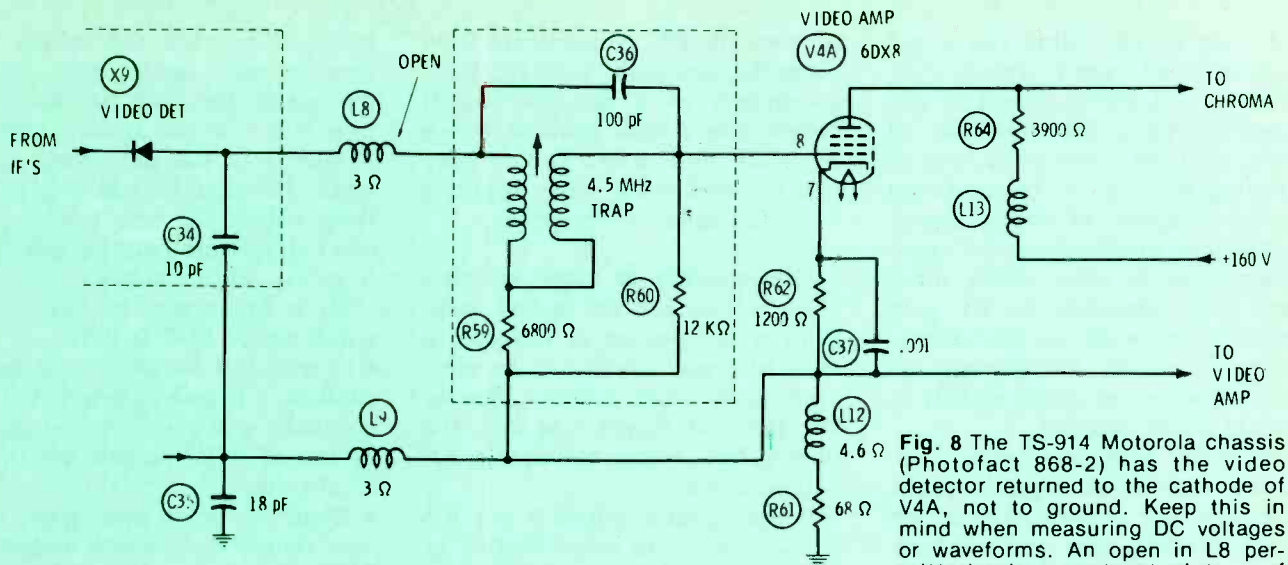

Fig. 8 The TS-914 Motorola chassis (Photofact 868-2) has the video detector returned to the cathode of V4A, not to ground. Keep this in mind when measuring DC voltages or waveforms. An open in L8 permitted a low-contrast picture of poor quality.

than 100 ohms, a shorted X9 diode would have been indicated. If both readings had been 12K, you probably could have found an open in the 4.5-MHz trap. Other opens and shorts can be analyzed in the same way.

Complete Loss of AGC

Symptoms of the next chassis were the classic ones for a total loss of AGC: normal snow on a blank channel, overloaded picture on strong channels, and little change when the AGC control was adjusted. Connection of a bias box to IF and tuner AGC points brought back a normal picture at about the correct bias voltages. AGC trouble was still indicated.

I removed the bias box and started measuring the DC voltages at the terminals of the AGC keyer tube and the AGC network (Figure 3). The first wrong reading was about +30 volts at the plate of V6A. Then sampling the voltages at the other ends of R39 and R40, I found the higher of the two voltages to be at C69, the IF AGC point. But there was one more possibility. One additional reading showed even more voltage (about +200 volts) at the junction of R50, R51 and R52. The correct voltage should have been about +16 volts, so this undoubtedly was the origin of the positive voltage that was overpowering the negative AGC voltage.

A couple of ohmmeter tests

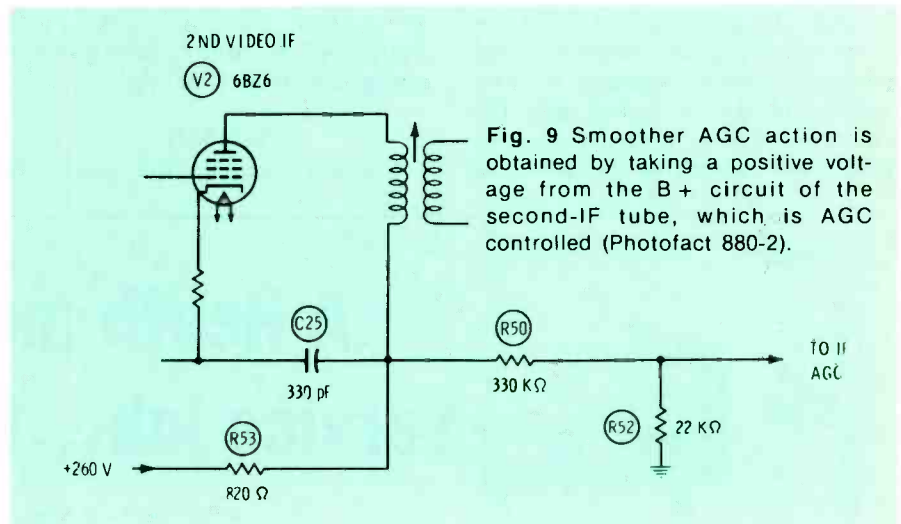

Fig. 9 Smoother AGC action is obtained by taking a positive voltage from the B+ circuit of the second-IF tube, which is AGC controlled (Photofact 880-2).

proved that R52 was open (Figure 9); and installation of a new resistor brought back the AGC.

Why is the positive voltage necessary?

Not all AGC circuits have positive voltage added to buck out part of the negative. In this circuit, it's required to overcome the high positive voltage at the cathode of the first-video IF tube. And it's obtained from the B+ circuit of the second-IF tube to give smoother AGC action. The second-IF tube has some AGC because it is direct coupled to the first IF, and this causes a small variation of the B+ voltage fed to the IF AGC circuit.

Snow And AGC

At first thought, there seems to be little connection between AGC performance and snow in the picture. But many technicians can testify to the many wasted hours they spent to learn the hard way that faulty AGC can cause snow.

Snow in a TV picture usually is visible receiver noise. In a smaller way, it is the same thing as the rushing sound you hear when the set is tuned to a blank channel. Atmospheric noise in the VHF and UHF bands is comparatively weak, and usually has less amplitude than the internal noise generated by the mixer stage of a typical TV tuner. TV circuit designers try to minimize

the snow by providing the mixer with a large input signal. Any reduction of signal ahead of the mixer increases the possibility of snow, and yet some reduction of RF-amplifier gain is essential during reception of strong signals to prevent overload of the same mixer stage. In other words, minimum snow demands no RF gain reduction on weak or moderately-strong TV signals, and only enough gain reduction on strong signals to prevent mixer overload.

Receiving localities having both strong and weak signals make necessary very precise AGC action to prevent both snow and overload, because there's virtually no tolerance between the two conditions.

Tube-equipped circuits always apply negative voltages to the grids of any tubes that are AGC controlled. To prevent the RF tube from receiving any negative grid voltage on weak signals, a fixed amount of B+ is leaked into the circuit. In Figure 3, this is done by R38. Grid current of the RF tube

prevents the DC voltage there from becoming very positive, so DC measurements of a normal circuit should show a small positive voltage on weak and moderately-strong signals, and a few volts negative when the signal is very strong.

The tendency of many resistors whose values are up in the megohms is to open or to increase in value with age. Therefore, the most likely parts defect causing snow in the circuit of Figure 3 is R38, the 10-megohm resistor connecting RF AGC and B+.

If the signal strength is not too high, a fast test to prove whether or not the RF AGC is responsible for snow is just to ground that AGC point. Any reduction of the snow is proof of too much RF tube AGC.

I won't give any more case histories about this defect, but it has happened in many, many other makes and models as well.

Summary

Correct AGC operation is

squeezed between the ceiling and floor of snow or overload. That's the reason the values of resistors in most AGC circuits are very critical. If your area has all strong or all weak TV signals, you can tailor those values for best results. Just don't stray more than perhaps 20% from the original values.

Here are some of the major symptoms of AGC defects:

- Overload of the picture (excessive contrast, a negative picture, buzz in the sound and poor locking) caused by loss of AGC particularly to the IF circuits;
- Blank raster or insufficient contrast caused by excessive amount of AGC; and
- Snow on channels that should not have snow.

If we include the video detector and the video amplifiers (after all, they are part of the loop), additional symptoms include poor bandwidth and locking. Use the short cuts explained before to determine whether or not the symptoms are caused by AGC problems. □

A Heath meter for every service job... from \$26.95*



Check these Heath values: a full-function kit-form 2½-digit DVM, just \$79.95*... a high accuracy 3½-digit DVM with a kit price of \$229.95*... and a complete line of kit or assembled VOMs and VTVMs priced as low as \$26.95*. Complete descriptions and specs are included in the latest Heathkit Catalog & the Heath/Schlumberger Assembled Instruments Catalog.



Send for your FREE catalogs now!

HEATH COMPANY
Dept. 25-7
Benton Harbor, Michigan 49022

HEATH
Schlumberger

- Please send latest Heathkit Catalog.
 Please send latest Heath/Schlumberger Catalog.

Name _____

Company _____

Address _____

City _____ State _____ Zip _____

Prices & specifications subject to change without notice. TE-308
*Mail order prices; F.O.B. factory.

BUSS®

the complete line of fuses, holders, blocks and clips to protect all electronic and electrical circuits and devices.

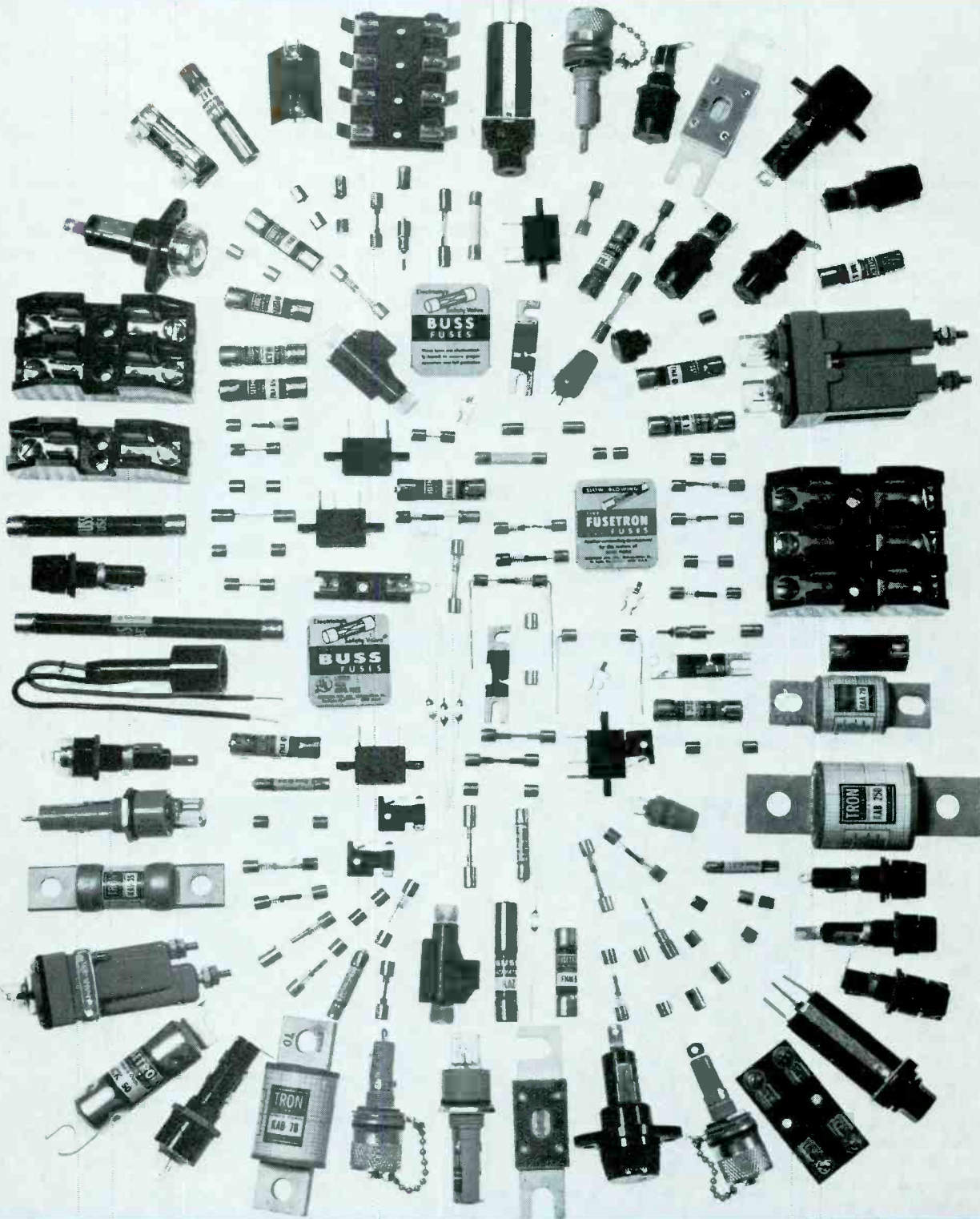

BUSSMANN MANUFACTURING
a McGraw-Edison Company Division
St. Louis, Missouri 63107

SUPPLIED THE ECONOMICAL WAY
THRU DISTRIBUTORS
BUSS FUSES
THE QUALITY LINE

Forest H. Belt's

Workshop on Hi-Fi tape recorders part 2

By Dewey C. Couch

Last month, in the Tape Recorder Workshop part 1, you learned the first steps to servicing hi-fi tape recorders. You start with a thorough cleaning. Then comes inspection. Both steps lead to a more detailed diagnosis.

This session covers two more facets: testing and adjustments. In the photos and explanations that

follow, you'll learn how to test important operations, and how adjusting assemblies tells you if they work okay.

Obviously not all operations or assemblies of every tape recorder model are covered. But those that are illustrated are basic and represent many others. The techniques covered here adapt easily to other machines. Carry these steps through conscientiously and they'll eliminate a lot of callbacks for you.

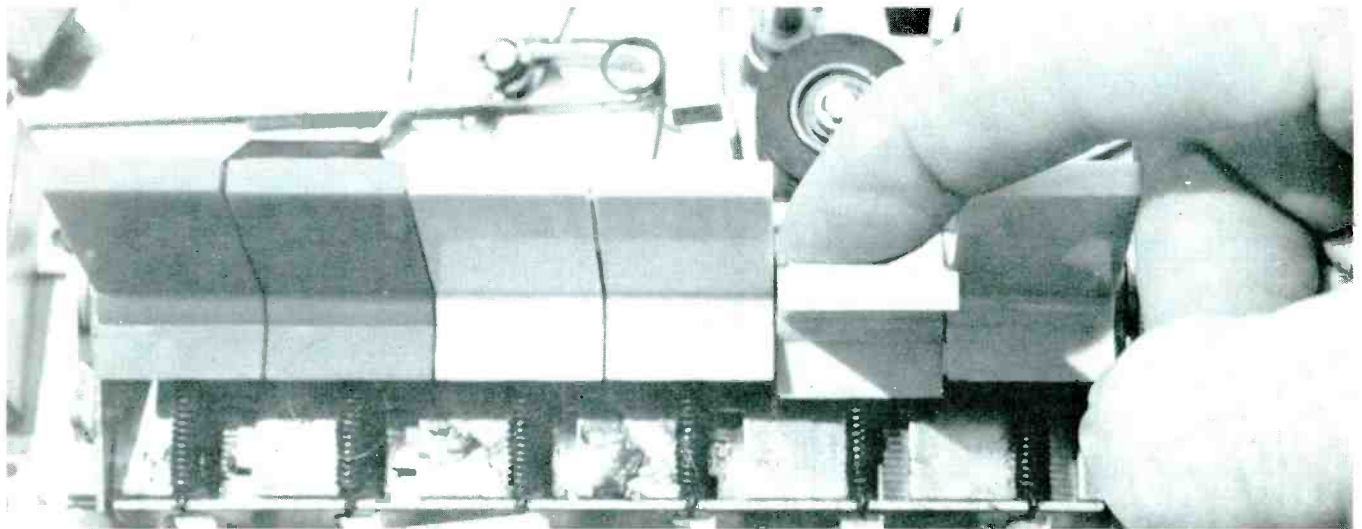

Step 1. After you have thoroughly cleaned and inspected the machine, try all its functions. Watch operation of the assemblies. First, punch the Play button. Check movement of the automatic-shutoff sensor (two varieties are illustrated here). The "feeler" wire type should move slowly and smoothly across the path of a properly threaded tape. Be sure it moves freely and doesn't bind. The other fits behind the tape as it's threaded. It, too, must move smoothly, spring-loaded, and you should hear its micro-switch click as you move the lever. A malfunction of either sensor can prevent the machine running or keep it from shutting off at the end of the tape.

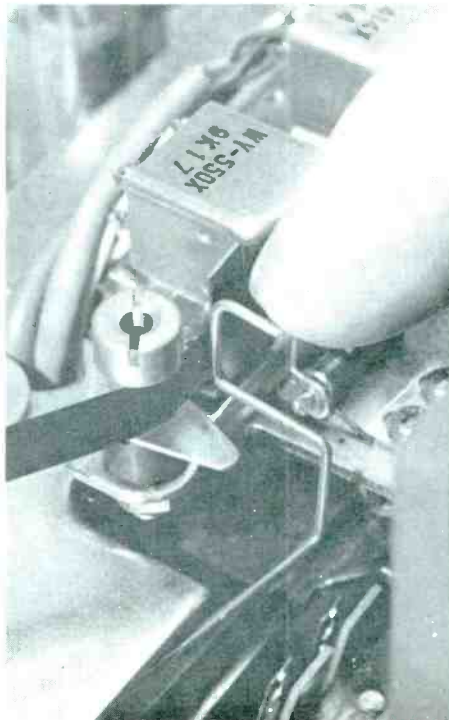

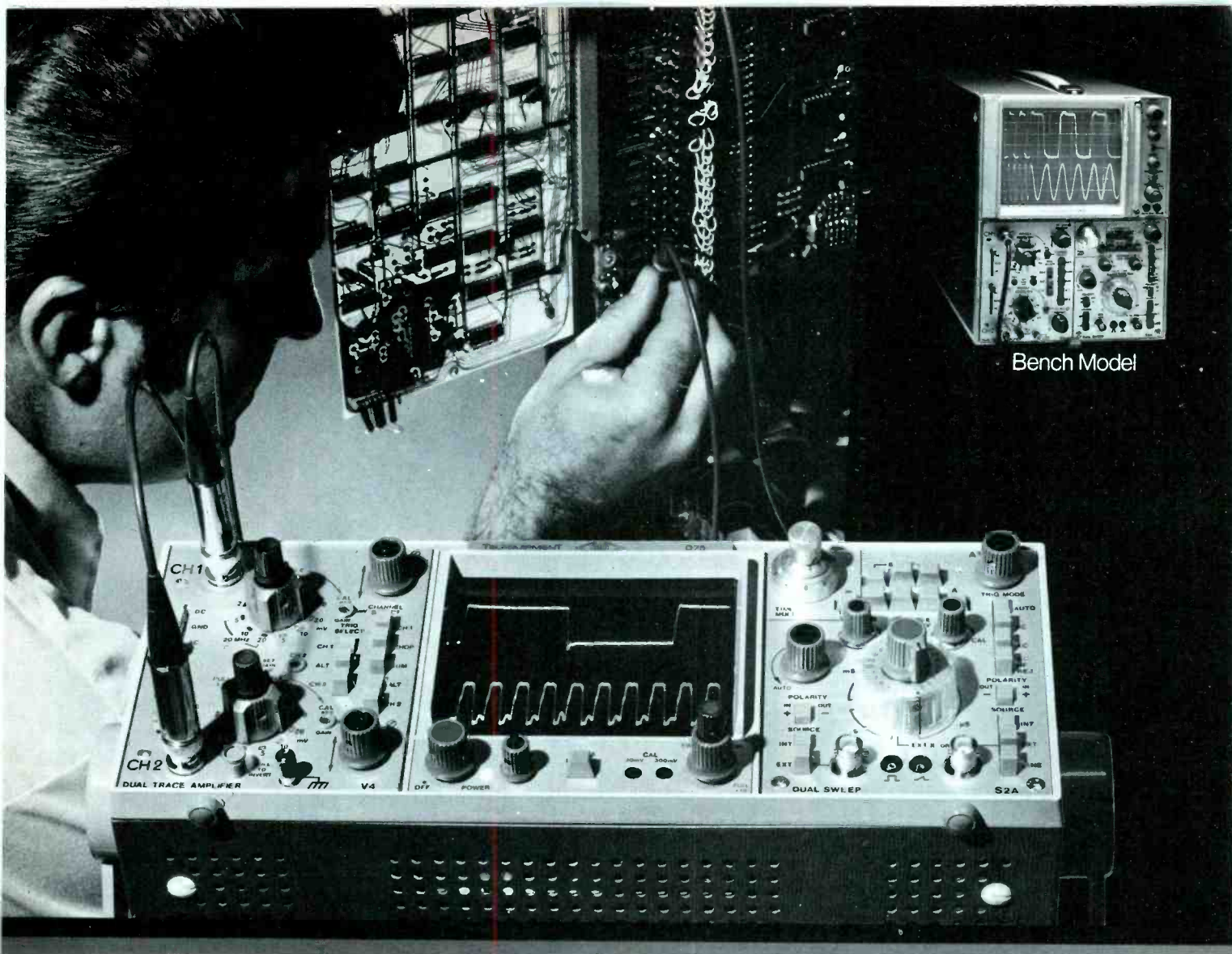

Bench Model

the Demand is so Great

We put one on the road

The demand is so great for low-cost 50 MHz dual-trace oscilloscopes that we offer two . . . the D83 Plug-in Oscilloscope and the D75 Portable.

The Telequipment D75 was designed with the electronic serviceman in mind. It trades the D83's plug-in changeability for easy portability. It's lightweight, rugged, and easy to hand-carry onto an airplane. The tilt handle snaps to thirteen different angles to conveniently position the instrument. The D75 costs only \$1375 with the same dual-trace amplifier and dual time base as the D83.

If you like the concept of plug-in selectability, choose the Telequipment D83 for only \$1495. Plug-ins include a differential amplifier (deflection factor 50 μ V/div to 10V/div), dual-trace amplifier (deflection factor

5 mV/div to 10 V/div), and dual time base.

Both have large CRT displays, plus delayed, single and mixed sweep. With the mixed sweep mode, you can view the delayed sweep portion simultaneously with the main sweep. Until now, you could only get this feature in more sophisticated scopes. Sweep speeds range from 100 ns/div to 2 s/div with accuracies within 3%. A magnifier (X10) extends the maximum sweep rate to 10 ns/div.

Tektronix backs all its Telequipment OSCILLOSCOPES with its one-year warranty.

D75 Oscilloscope	\$1375
D83 Oscilloscope (without plug-ins)	\$ 800
V3 Differential Plug-in Amp	\$ 295
V4 Dual-Trace Plug-in Amp	\$ 295
S2A Dual Time Base	\$ 400

Demos and models for sale are ready for immediate shipping. Call your field engineer, or mail this coupon to Tektronix, Inc., P.O. Box 500, Beaverton, Oregon 97005.

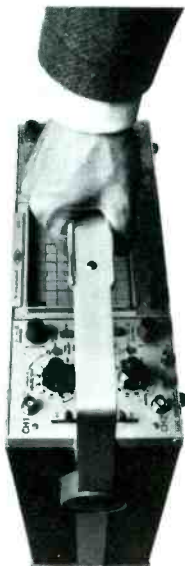

Name _____

Company _____

City _____ State _____ Zip _____

I would like a demonstration.

I would like more information.

Enclosed is my letterhead/purchase order for immediate shipment.



TEKTRONIX
committed to technical excellence

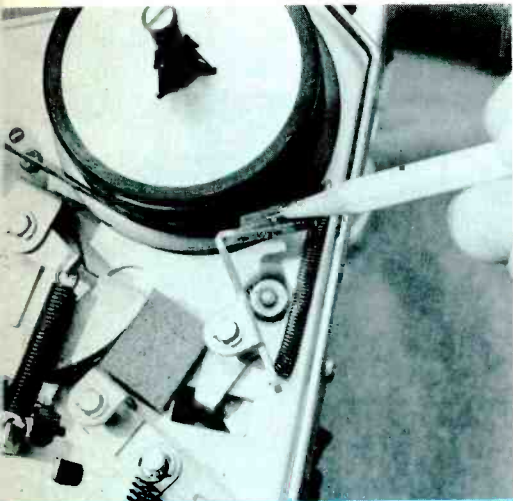

Step 2. Press each pushbutton and watch how the associated linkages and levers move. They must move freely. Make sure a brake isn't left dragging. Assure yourself that no levers are bent or binding. Check all idlers and see if they come into tight contact with the wheels or pulleys that drive them—or that they drive. Check their tension; not enough can cause slippage in the drive train, resulting in wow or a "stuck" tape.

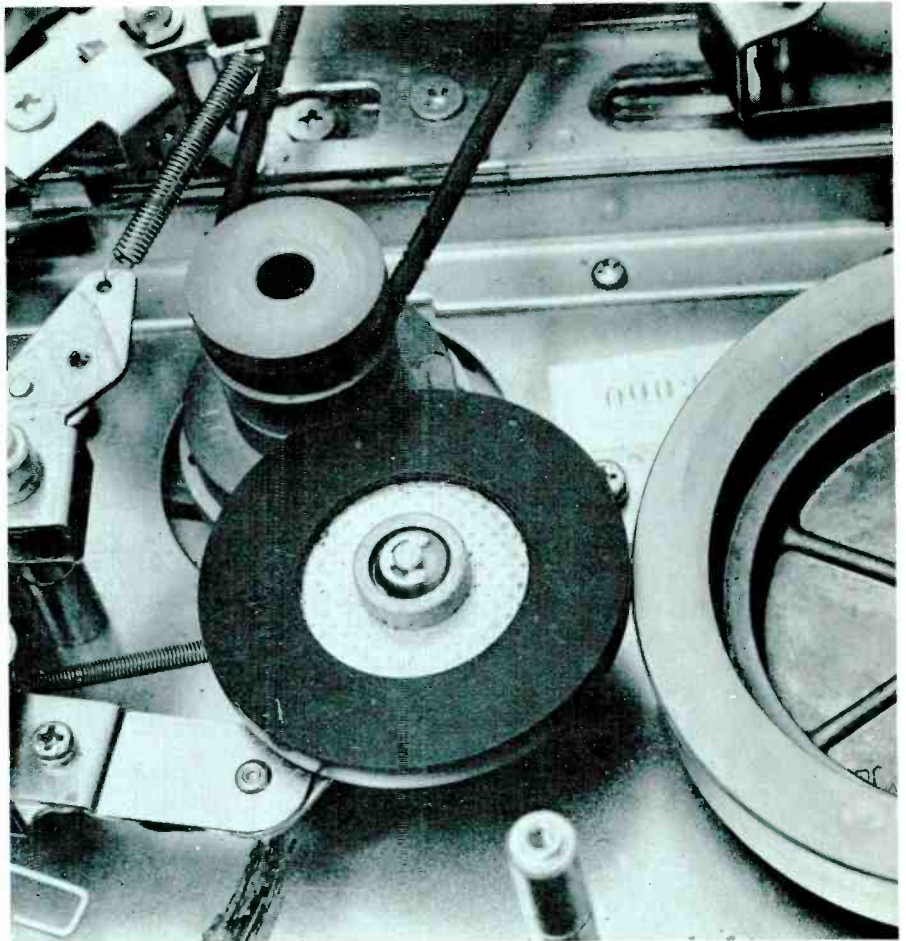

Step 3. Try different speeds. Move the speed-change knob to each setting and see if the mechanism switches to the proper speed. You can tell by watching how fast the flywheel turns when you punch the Play button, or by observing closely the movements within the drive assembly as you switch the speed knob.

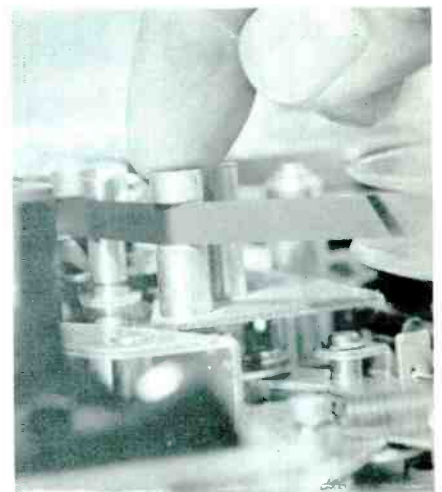

Step 4. With the tape threaded and the machine playing it, watch how the tape moves through the tape guides. It should seat evenly in the guide, with no upward or downward movement. There should be no crinkling of tape edges, nor any twisting of the tape. Sight along the tape's level; it should move **straight** from the supply reel, through the guides, and past the head, all at the same level.

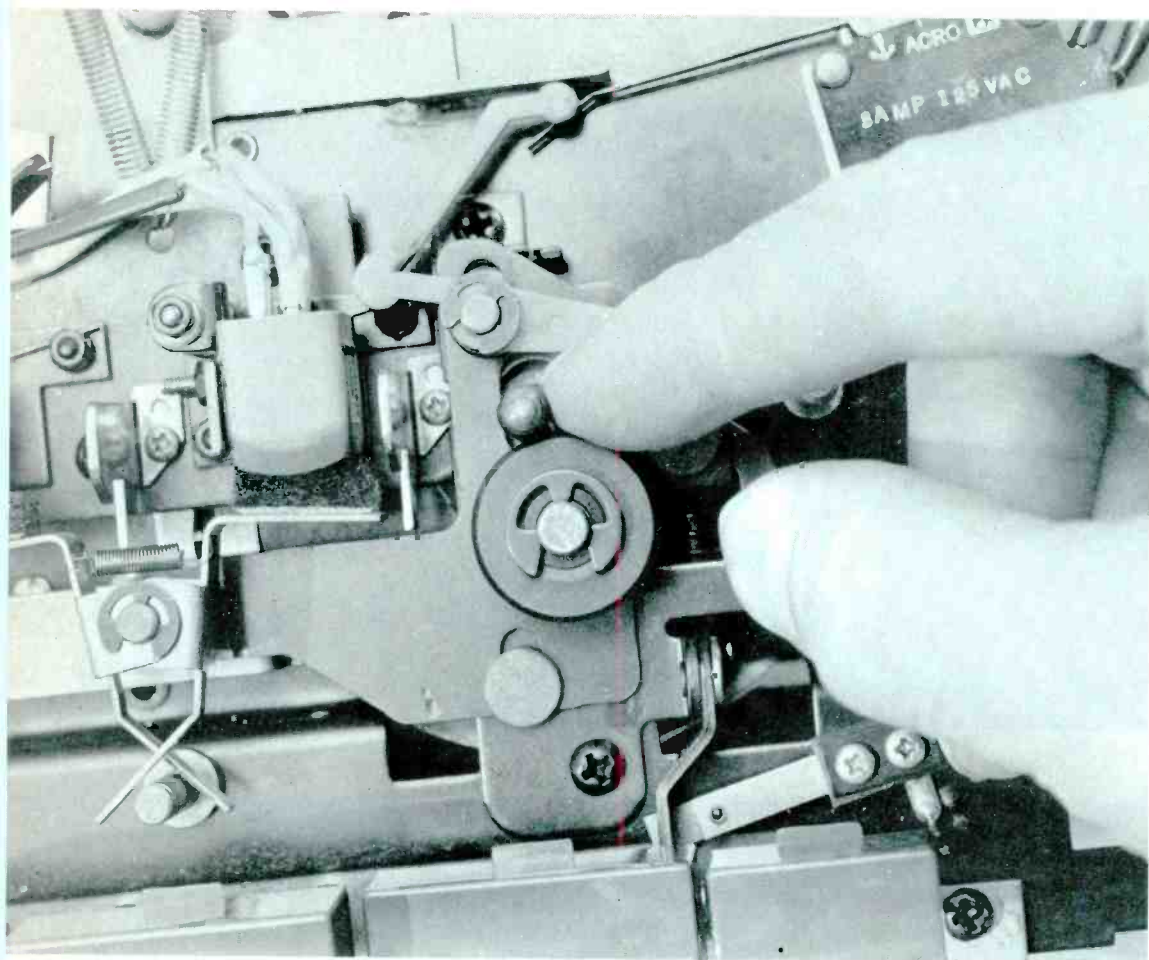

Step 5. Check the capstan where it rotates against the pinch roller. It should spin perfectly centered, without the slightest trace of wobble. Also observe the tape as it moves between capstan and roller. Any upward or downward movement of the tape means the capstan is warped or the roller does not seat properly against the capstan. If the capstan is bent, you must replace the entire flywheel assembly. As for a poorly seated pinch roller, a bent mounting lever or shaft might be the culprit; replace the whole assembly.

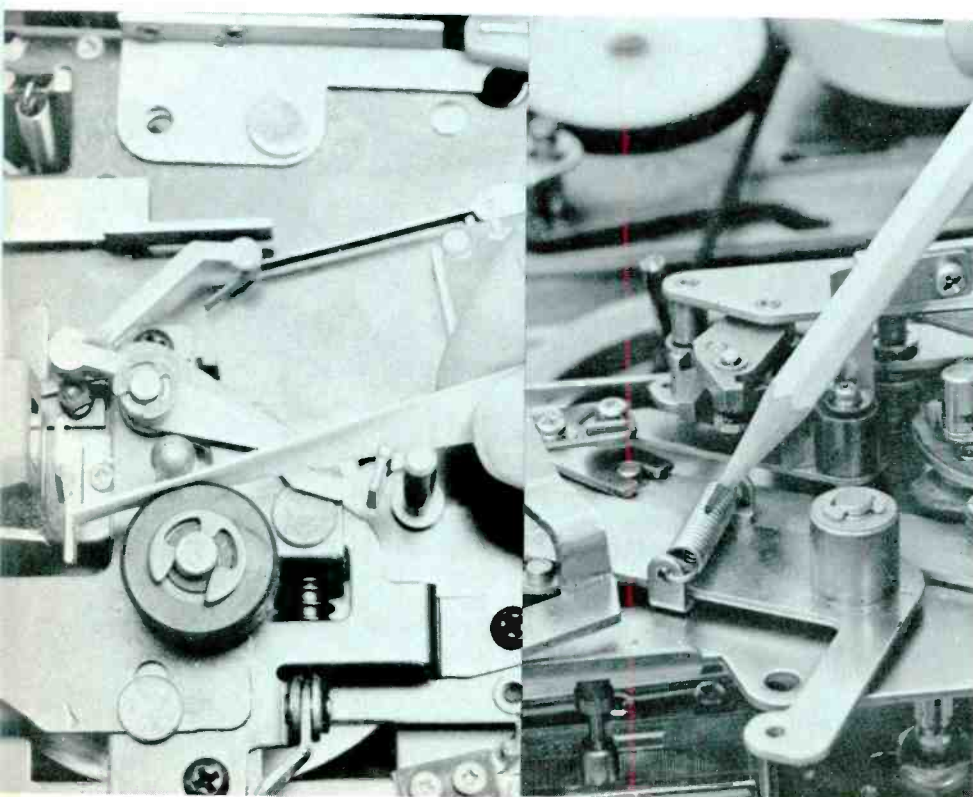

Step 6. Pressure between pinch roller and capstan is very important. Tension should be enough to hold the tape firmly against the capstan, but not enough to tilt the roller or depress its rubber contact surface. To check, place a strip of paper between the roller and capstan and punch down the Play button (with power off). If roller pressure is correct, you won't be able to pull the paper out easily. If you can, the pinch-roller tension spring probably is weak. Try a new one. Some machines allow adjustments of this tension; you can move the spring end from one hole to another for proper tension. Tighten the roller pressure just enough to hold the strip of paper. Don't overtighten; that can cause erratic tape speed, bend the roller shaft, or even break a tape.

Step 7. Squeaking and excessive oxide buildup on the heads can result from pressure pads being too tight. These are the felt pads that keep the moving tape in smooth contact with the magnetic heads, right at the gap. The pads usually mount on hinged plates; a light spring tension holds them against the heads. To adjust, punch the Play button with power off. Loosen the pad assembly mounting screws. Position the plate so the pads press lightly and evenly against the heads. Then retighten the screws.

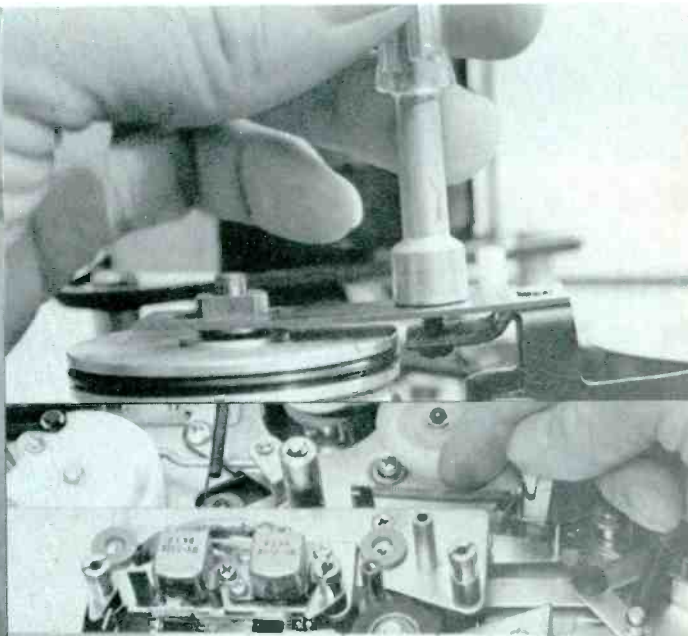
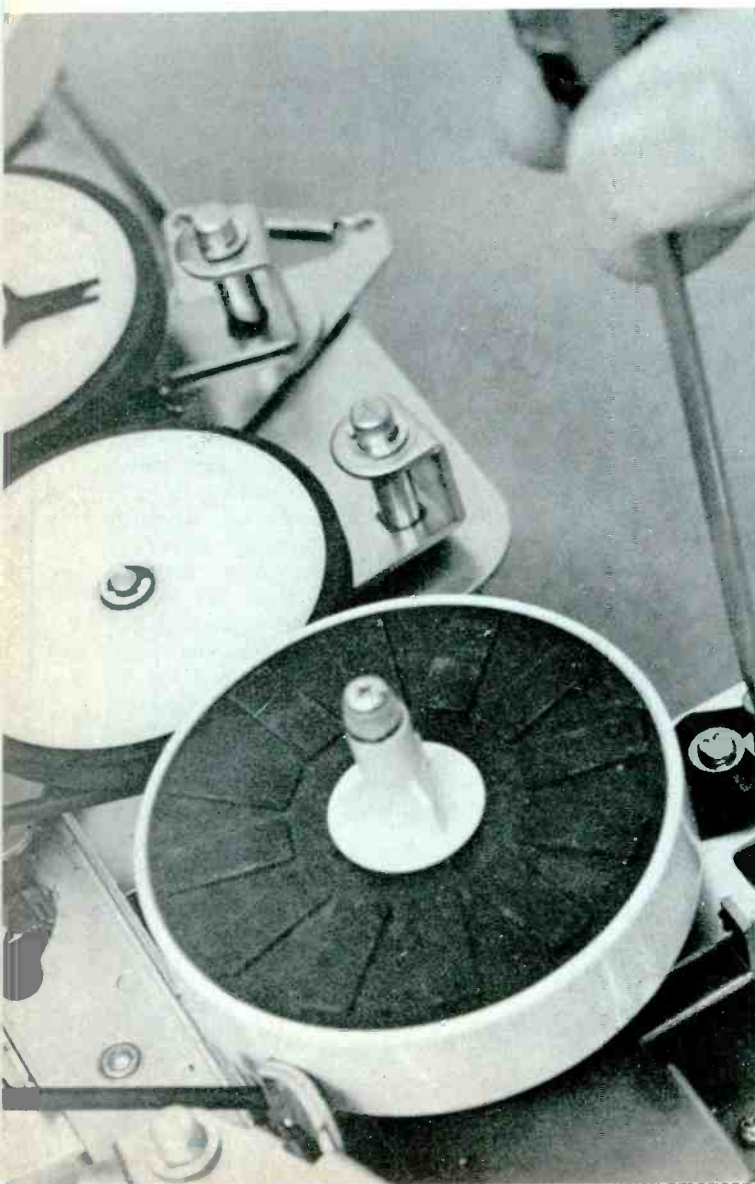
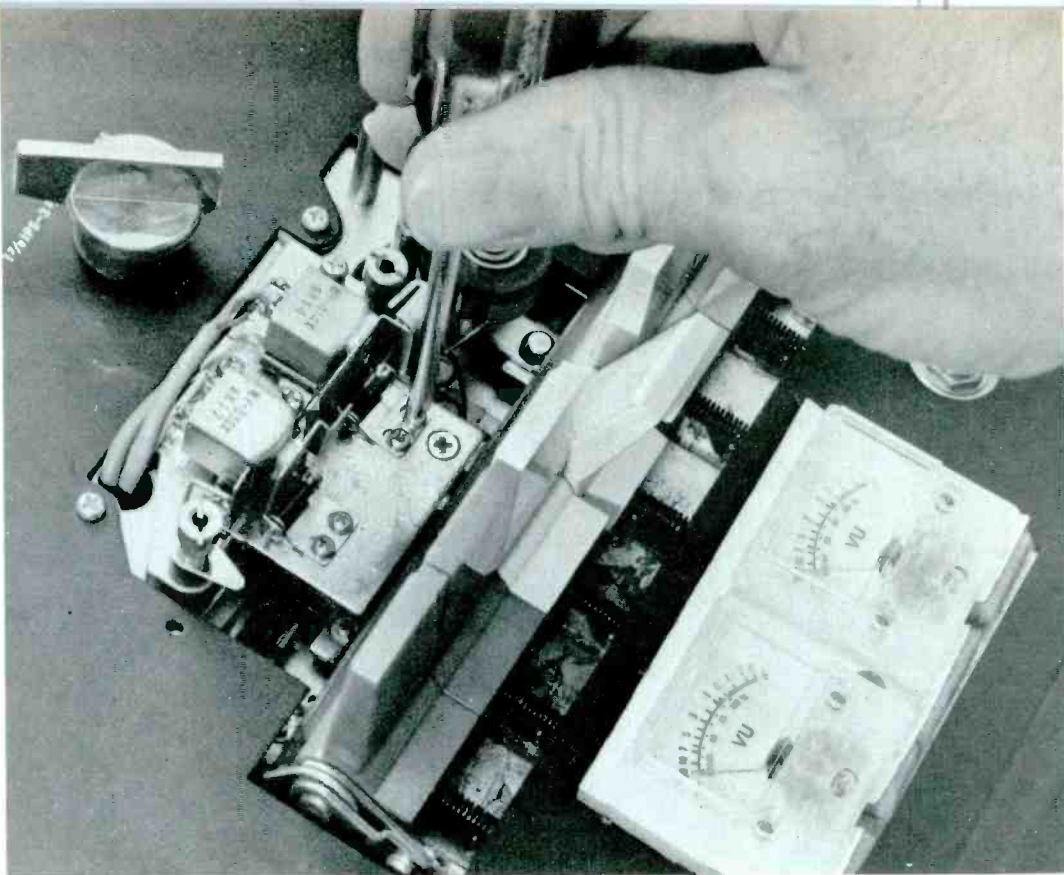

Step 8. Torque of supply and takeup spindles is important to normal operation. This determines how much pull the spindles exert on the tape. Takeup torque is generally set by a clutch in the takeup spindle assembly. Many are not adjustable, relying on the weight of the reel or on a spring to determine tension. But you can adjust some. Press the Play button (with power off and a tape threaded). Adjust clutch tightness until the tape, with power on briefly for testing, stays taut from the capstan and pinch roller to the takeup reel. The danger is in overtension on the tape, which stretches it, and could break it. Too little pull causes tape spills.

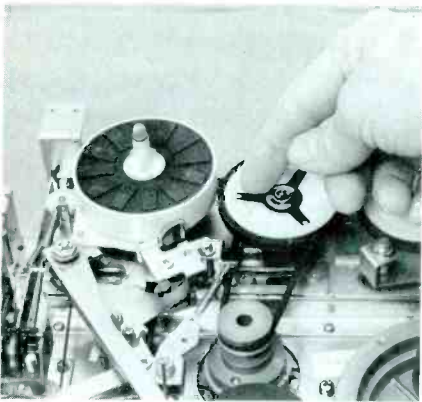
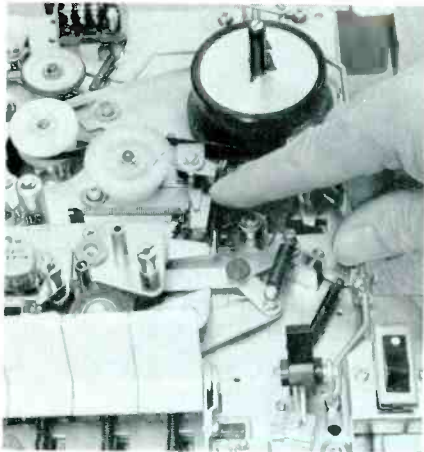

Step 9. Torques during fast-forward and rewind are always stronger than during playback. Spring tension draws an idler against the spindle and the motor pulley to turn the spindle at high speed. Sometimes the idler is belt-driven. Generally, neither of these are adjustable. They rely solely on spring tension to maintain high-speed drive contact. A few models have a fast-speed clutch assembly (also illustrated here) that you can adjust. Move the spring counterclockwise to increase torque or clockwise to decrease it. Notches in the idler hold the spring where you set it. Adjust the spring so the reel pulls the tape through rapidly, without spilling or "floating," whenever you press the Fast Forward or Rewind button.

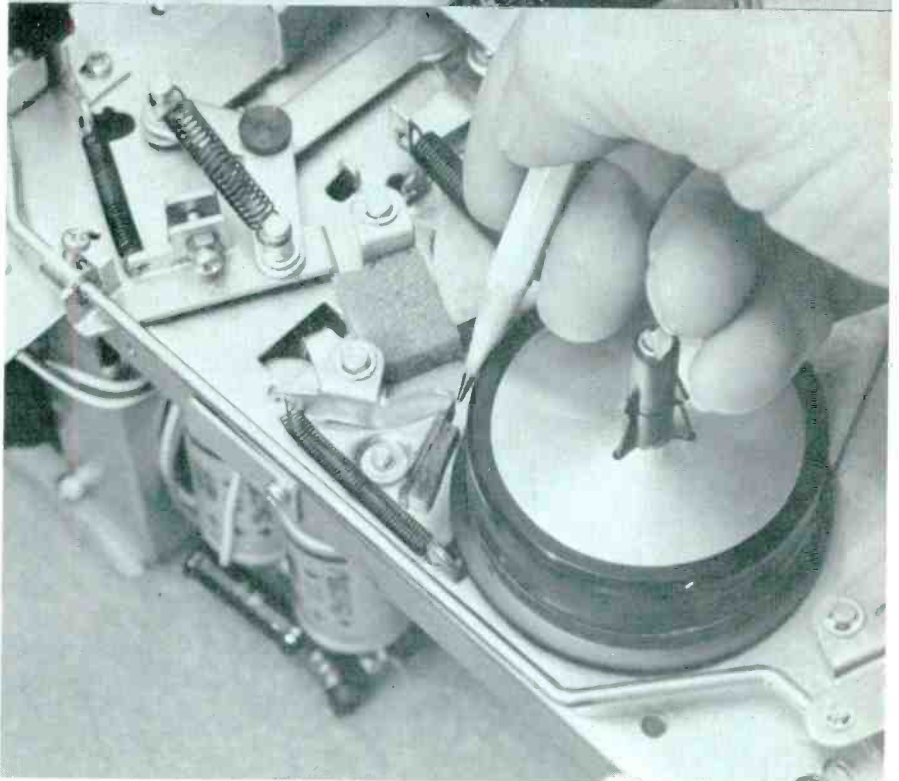
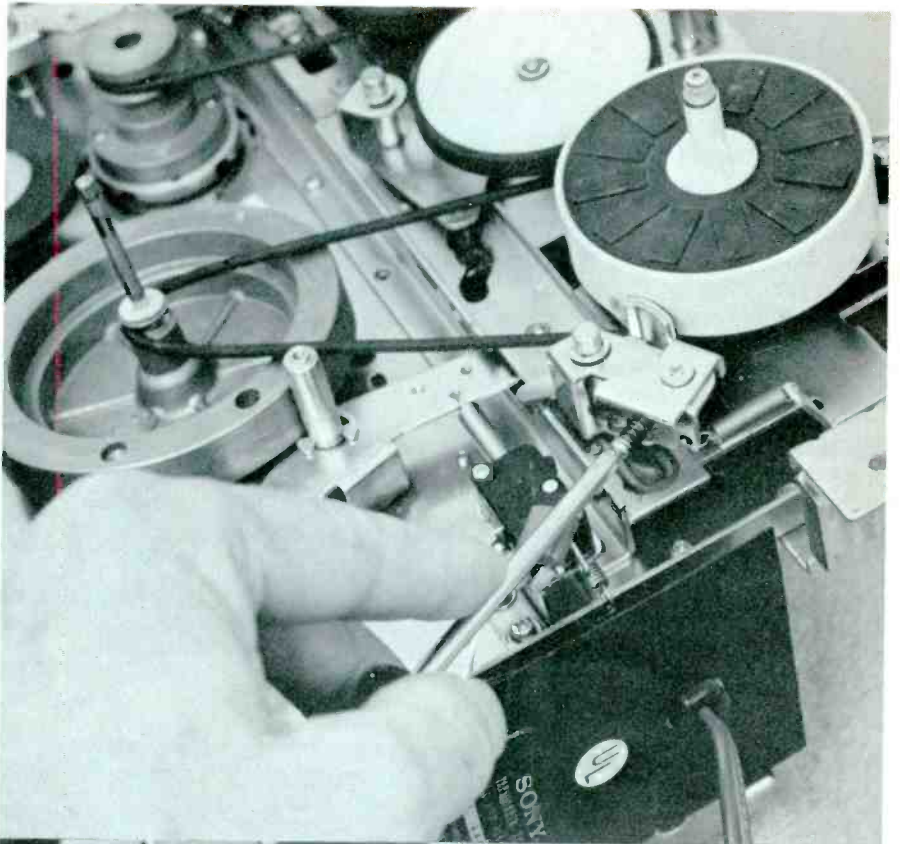

Step 10. Brake shoe adjustment can be critical. Brakes should stop the spindles within a quarter of a second or so, when you punch the Stop button. Yet, they must completely free the spindles during Play, Fast Forward, or Rewind. Brakes usually rely on spring tension for their stopping pressure. Some are adjustable. Compromise the setting until the shoes move well clear of the spindles when the Play button is down, but press tightly against the spindles when you push down the Stop button. Band-type brakes (not shown) may have a bolt/nut adjustment.

Step 11. Record/play heads always have at least one adjustment: azimuth (or tilt of the gap). Some have height and zenith adjustments, as well. A few even have a tangent adjustment. You can buy test tapes to aid in getting these adjustments right. First, adjust the tangent screw, if the machine has one. With the power off but the play button pushed, loosen the two mounting screws and position the head so its front-to-back axis is exactly perpendicular to the tape. This puts the tiny microgap of the head precisely against the tape. Retighten the screws securely after you have the head aligned.

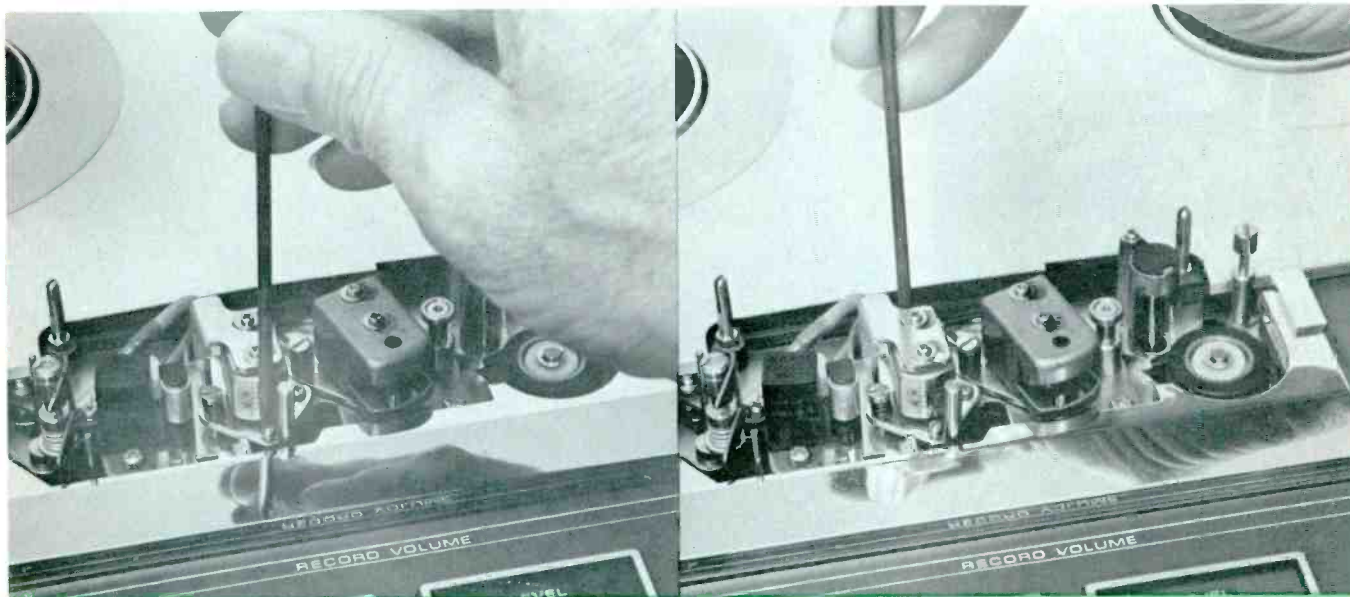
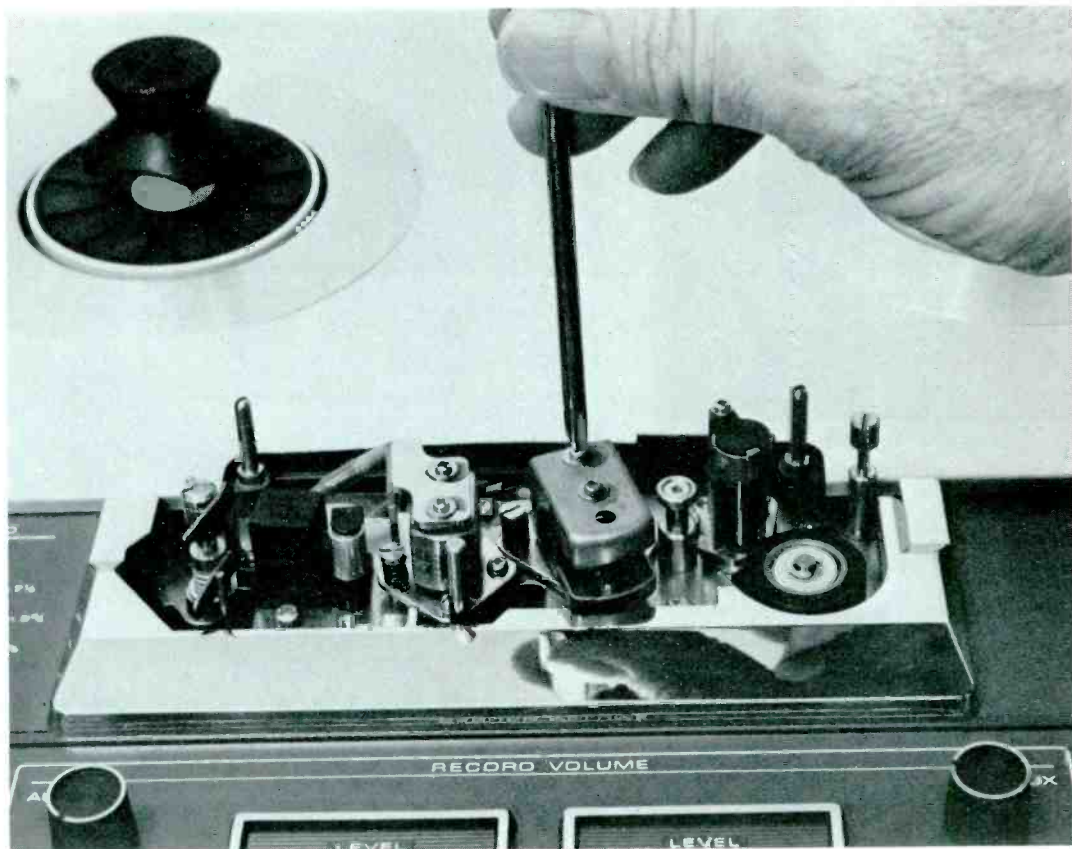

Step 12. Head height comes next. Often, there are two adjusting screws—one front and one rear. Adjust them alternately until the upper edge of the tape is even with the top edge of the upper head gap. The front screw might also be used for zenith adjustment. Turn it slightly until the tape rests evenly from top to bottom against the head face. This might necessitate readjusting the rear height screw, too. To be sure you have both adjustments right, play a test tape and check for maximum and equal outputs from both tracks. You can generally use the built-in VU meters; or, check across the preamp outputs with an audio VTVM. Retouch the height and zenith adjustments several times if need be.

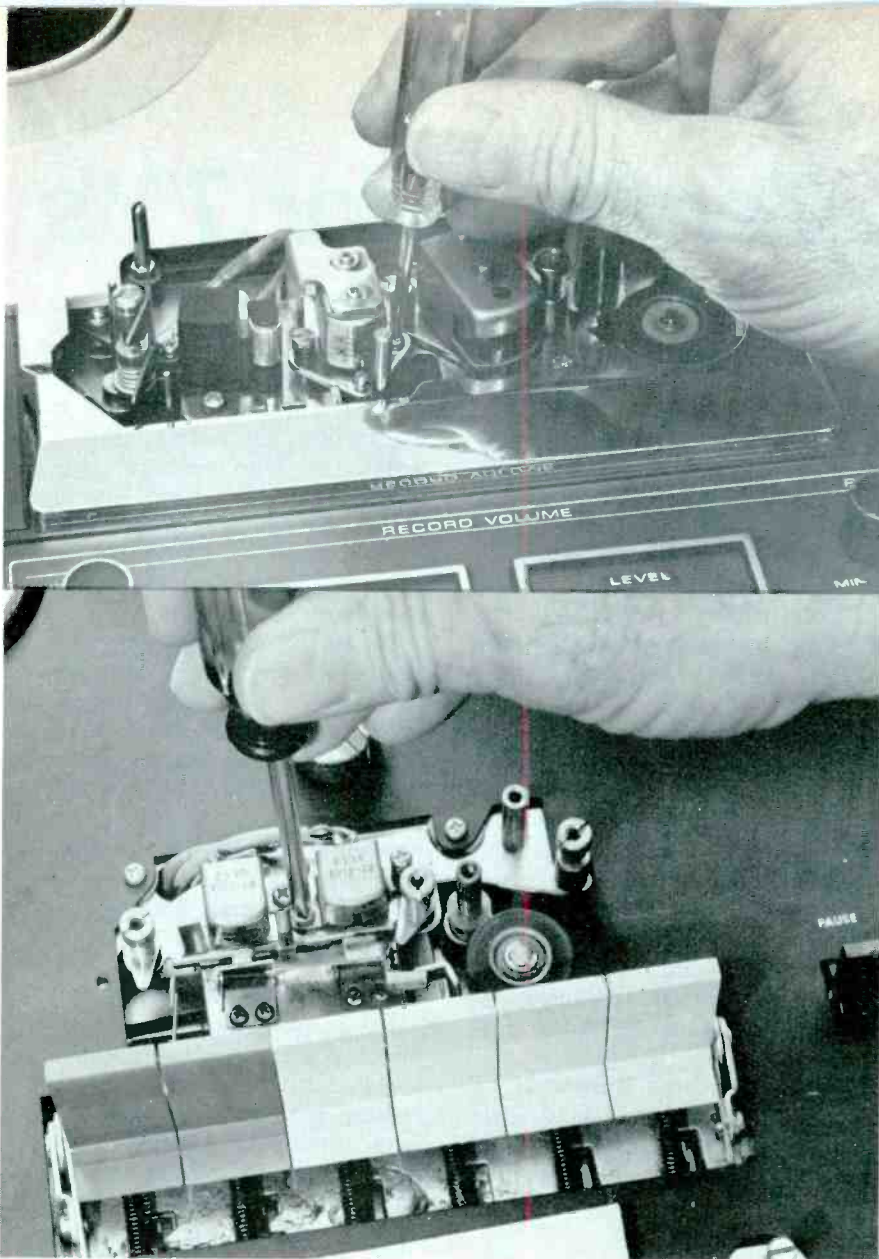

Step 13. The final head adjustment is azimuth. The adjustment is rather simple, but critical. You play the azimuth portion of your test tape and adjust the screw for maximum output on both VU meters. The screw sets the tilt of the head. It's correct when the microgap is perfectly vertical. Recheck head height after you've made this adjustment.

Coming Next Month

Test and adjust any tape recorder you get for repair, before you begin more complex diagnosis. You'll discover that a lot of faults are uncovered and even cured by these preliminary procedures. Once you're finished with repairs, run through them again quickly. The few extra moments may head off costly callbacks.

For the final diagnosis, you need to really understand operation of the machine. You can then figure out most troubles by watching the machine's attempts to operate. To aid you in this ultimate analysis, the third Tape Recorder Workshop session shows you the key operations in two typical hi-fi tape recorders. □

service breakthrough

Guesswork is gone!...

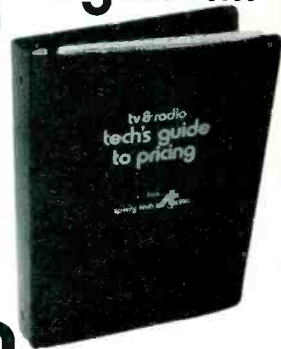

in flat rate pricing!

Now, for the first time, one compact book guides you through the pricing hazards encountered in today's major categories of TV and radio repair. No more guess work. The building block system automatically provides an accurate pricing method for each step or adjustment involved. Each step is priced according to its complexity or magnitude. Also, there's a bonus section in the book that provides new business planning insight, that gives you an edge in all areas of pricing. **It's simple to use!** 1... index to the product repair. 2... total times for each repair. 3... convert time to price on the calculator page. (converts time to price in any area of the U.S.). Order now! A must for every shop owner...**Don't delay another profit day** simply fill out and mail the coupon below.

\$18⁰⁰ per issue, postpaid.

(Nebr. residents add city and state sales tax)

tv & radio
tech's guide
to pricing

sperry tech inc.

P.O. Box 5234
Lincoln, NE. 68505

- More information please.
- My check or money order enclosed.

NAME _____
 COMPANY _____
 ADDRESS _____
 CITY _____ STATE _____ ZIP _____

For More Details Circle (12) on Reply Card

Servicing Zenith color TV's

By Robert L. Goodman, CET

The "Old Pro" gives more examples of troubleshooting techniques applied to troubles in Zenith color receivers.

TV troubles often happen in bunches. Some days all the symptoms seem to indicate sync problems. At other times, most of the repairs involve flyback replacements. On this day, for a change, all the bench jobs were in different circuits, but they were in just one brand: Zenith. In addition to telling of the exact trouble found in each case, I will give methods to be used for finding other similar defects.

Intermittent Foldover

At times, the picture on the screen of the Zenith color set with a 25DC56 chassis blacked out because the high voltage was lost. Occasionally, the raster would show a foldover in the center of the screen (Figure 1). It was not clear whether there was more than one defect.

My first thought was that the intermittent condition might be originating in the horizontal oscillator or driver. I connected the low-cap probe of my triggered-sweep scope to the base of Q803, the horizontal driver transistor. Only a slight change of amplitude

was noticed when the intermittent occurred.

At the collector of Q803, the amplitude would increase simultaneously with the foldover. However, the waveshape didn't change enough to account for the symptom. Next, the probe was moved to the base of Q216 (Figure 2) where the amplitude increased and the waveform (normally a square wave) changed greatly when the problem occurred.

This test seemed to pinpoint the defect, but did not indicate whether T206 might have an open secondary, or that Q216 might be defective. After a few minutes thought, I decided to try one more testpoint at the junction of C264 and R353. With normal operation there should be almost no signal, but during the intermittent foldover, the amplitude was about the same as at the base of Q216.

These symptoms indicated an intermittent open in C264, so I was not surprised to find a poor ground at the positive terminal of C264.

General information

You will notice there is no source of positive DC bias for the base of Q216. Instead, the positive-going parts of the square waves from the driver transformer bias the transistor into conduction. Therefore, a

complete loss of drive to the base of Q216 produces nearly zero collector current; there is no bias to cause conduction. Of course, this eliminates the high voltage and the raster, but the output transistor suffers no damage; it merely idles. That's one way the symptoms of drive failure are just the reverse of those with tubes.

If you want to try the test for transistor conduction by shorting together the base and emitter (the short should eliminate all conduction), turn off the power before making the short, and turn off the power after making the test before removing the shorting jumper. An intermittent connection could generate transients that might ruin the output transistor.

Audio Problems

By coincidence, the next two bench repairs involved problems in the sound circuits.

Here are some general tips. Defects in the sound circuit before the detector can cause buzz or insufficient volume. Problems in the detector stage might produce buzz, hum, distortion, or low volume; while troubles in the audio output stage are likely to be low volume, distortion or hum. Some types of distortion produce a raspy sound, while others merely seem to make

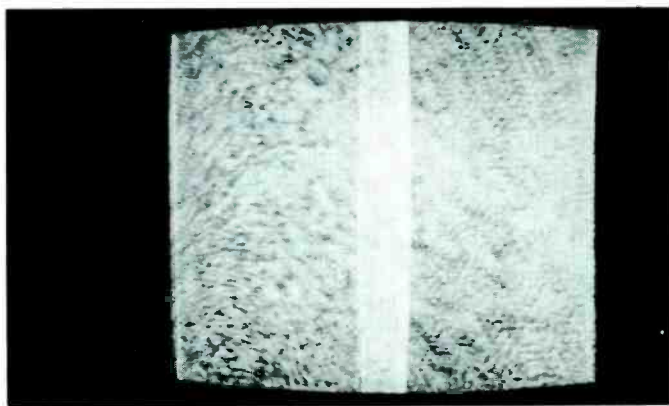

Fig. 1 A 25DC56 chassis Zenith (Photofact 1312-3) intermittently gave this foldover of the horizontal sweep.

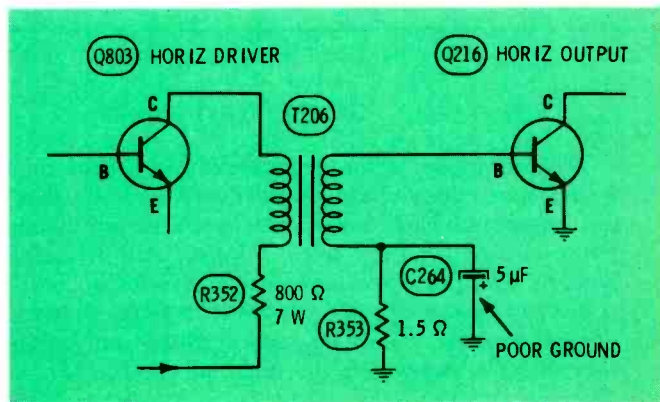

Fig. 2 Partial schematic of the driver and horizontal-output stages of the 25DC56 Zenith shows the capacitor causing the intermittent foldover and occasional loss of raster.

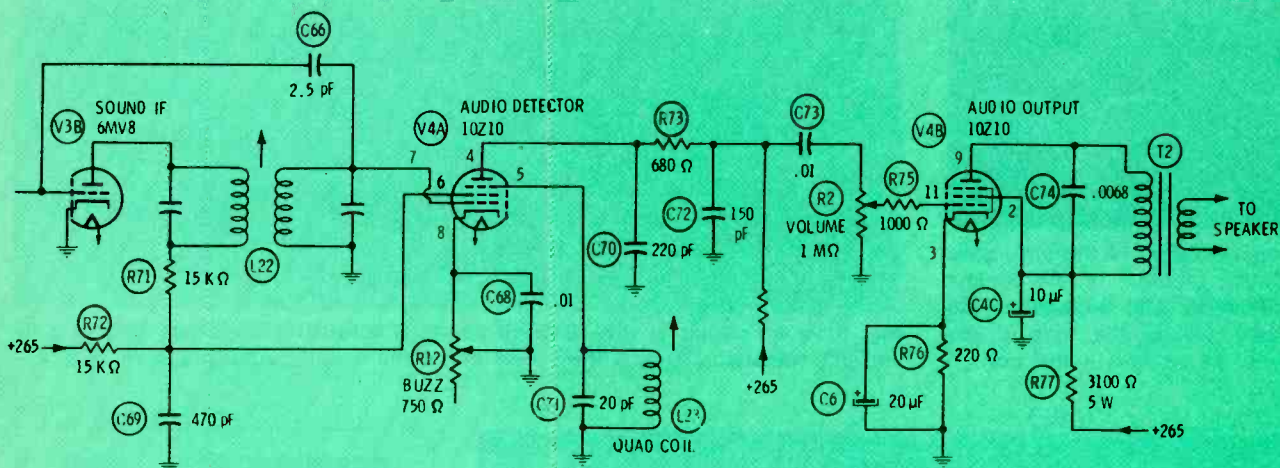

Fig. 3 Sound-circuit schematic of the Zenith 14DC16. Buzz on the station is affected largely by adjustments of the buzz control and L23 (the quad coil) plus the amplitude of signal at pin 7 of the 10Z10. Several causes of distortion in the

output stage are explained in the text. A speaker with an off-center voice coil often sounds much worse at low volume than at high level, just the opposite of most electronic defects.

the music sound as though it had too much treble. Buzz is a raw sound caused by pulses or square waves in the audio (perhaps from video waveforms), but hum is a deeper, smoother sound whose source is 60-Hz or 120-Hz near-sine waves.

Low volume

The repair order said "weak volume", but at first the performance of the Zenith 14DC16 (Figure 3) was normal. During the first 15 minutes, the volume gradually dropped and became somewhat distorted. When I tried the volume control, the tone quality and volume were okay at low settings. But, above the half-way mark, the volume failed to increase, and distortion appeared.

These symptoms don't seem to make sense until you consider the effects of resistance on any voltages leaking into a circuit. In this case, two defects are the most likely to cause the problem: leakage in coupling capacitor C73, or a gassy 10Z10 audio output tube.

Suppose C73 is leaky. It will bring positive voltage from the previous plate to the high side of the volume control. The higher the control is turned, the more positive voltage is applied to the control

grid of the output tube. Positive grid voltage produces distortion and excessive plate current; therefore, the high value of R77 reduces the plate and screen voltage, decreasing the volume.

A gassy output tube causes the same audible symptoms, but produces a different set of voltage readings. More resistance from grid-to-ground (higher volume control setting) causes a more positive voltage at the grid. The increase of plate current and the decrease of volume is the same as when C73 is leaky. However, the grid of the output tube is more positive than the high terminal of the volume control. Whereas, in the previous case of C73 leakage, the high terminal of the volume control was more positive than the output grid. That's how you easily can prove which component is defective. **In this case, the output tube was gassy.** Clipping of a sine wave is shown in Figure 4.

Negative grid voltage

What would you do if you measured the grid voltage and found it negative, rather than positive? That can happen if the output tube has too little bias.

Suppose the output tube develops a cathode-to-heater short, or the

cathode bypass capacitor shorts. True grid bias is grid-to-ground voltage (zero without signal) minus the cathode-to-ground voltage (now zero). Therefore, the tube has zero bias.

But when the volume control is turned up, the grid/cathode elements of the tube act as a diode to shunt-rectify the audio signal. Such rectification produces negative voltage, which varies with the volume setting and the loudness of the program. The positive going tips of the audio signal draw grid current, so at that time the plate current is excessively high. Then between the tips, the grid voltage is negative, and the plate current is nearly cut off. As you can imagine, this creates huge amounts of distortion.

Incidentally, a general tip for any brand with a similar circuit is that **arcs inside the audio output tube can burn a bad spot on the element of the volume control. To prevent a second recurrence, increase the resistance of R75 to 100K ohms.**

Open capacitors

An open C6 (cathode bypass) or C4C (supply filter) reduces the volume, although the reason is different in each case.

First of all, remember that R77, the tube, and R76 are all in series



Fig. 7 An open in either of the complementary-symmetry vertical output transistors can limit the deflection and move it to either the top or bottom, depending on which transistor is bad.

would pop and disappear in the Zenith 4B25C19 of Figure 5. This sound circuit has only one IC and one transistor. The IC functions as sound-IF amplifier, product detector, and first-audio stage. Audio is taken out of the IC to the volume control, and then is routed back to the internal first-audio part of the IC. Output from the first-audio stage goes through C7 to the base of the output transistor.

Troubleshooting tests

The recommended way of dealing with intermittent audio is to locate the stage where the signal disappears. This is best done with a dual-trace scope (although a regular scope can be used by taking twice the number of waveforms).

To begin the tests, I applied one low-cap probe to the high side of the volume control and the other probe to the base of Q11. When the audio stopped, both scope waveforms still remained. This proved the defect was not in the IC or in C7, but was between the base of Q11 and the speaker. I moved one probe from the volume control to the collector of Q11, and there the waveform disappeared with the loss of audible sound. The intermittent simply had to be in the Q11 stage.

Of course, the loss of sound might have been caused by an open R99 (base bias resistor), or an open R101, R102 or R104. The tests needed to narrow the possibilities call for analysis with a DC voltmeter.

When the intermittent occurred, the base voltage of Q11 increased slightly (ruling out an open R99),

the emitter voltage went to zero, (no chance of R101 or R102 being open), and the collector voltage went up to +270 volts, the supply voltage. Based on these voltages, only one conclusion was possible: transistor Q11 was opening intermittently.

General information

It's possible that the "hot" and "cold" technique might have worked well here. To try it, slightly heat the chassis enough for the intermittent to show up, then carefully spray just **one** component at a time with canned coolant. The component being sprayed when the sound returns is probably the bad one. A tiny amount of coolant often is sufficient. You can make a wrong diagnosis if the coolant lands on more than one part.

C7 is a non-polarized electrolytic, the equivalent of two capacitors wired back-to-back. A non-polarized type is needed here because the DC voltage from the first audio stage inside the IC changes with signal strength and fine tuning. Although the IC end of C7 is positive relative to the following base when no signal is tuned in, under other conditions it might be less positive and cause undesirable leakage.

Two devices are used to protect the output transistor from damage. One is the varistor which is connected in parallel with the primary winding of the output transformer. If the volume control is advanced too far, or the set is operated without a speaker while the volume is high, the varistor decreases resistance to reduce the maximum AC voltage applied to the transistor. A new varistor is packed with each replacement transistor. To prevent future failures, it should be installed at the same time as the transistor.

Additional protection is afforded by R104, which also doubles as a filter resistor. If for any reason the collector current of Q11 increases, more voltage is dropped across R104, leaving less for the transistor. Thus the maximum wattage to the collector is kept to a safe value.

Bias problems

One of the lessons we must learn in order to successfully service

solid-state equipment is the large changes of transistor gain caused by small changes of bias. A bias that is **almost** correct, just might be all wrong. True bias is the voltage **difference** between base and emitter; a change of either voltage is a change of bias.

Generally speaking, a true bias change of only .05 volt from optimum will affect the gain radically; while a change of .10 volt will seem to eliminate all gain. That's critical!

Don't allow an emitter voltage that is almost correct to fool you.

An open emitter lead inside the transistor of Figure 5 produces a zero emitter-to-ground reading. But an open in either R101 or R102 can give a **nearly-correct** reading that's very confusing. If the resistor is completely open, the transistor can conduct only when you connect the resistance of a meter across the resistor that's open. Then the transistor conducts a microscopic amount of current, which develops a fair amount of voltage because the resistance is so high.

Opposing forces are at work. Increased emitter current produces more emitter-to-ground voltage (less forward bias), which decreases the emitter current. Also, less emitter current produces decreased emitter voltage (increased forward bias) which increases the emitter current. The end result of all these effects is a point of equilibrium with the emitter current very small, but enough (because of the high resistance) to produce an emitter-to-ground voltage of about **.5 volt less than the base**.

Notice the possible trap set up by the small differences between normal and abnormal voltages. Referring to Figure 5, the new base voltage might be +4.1, and the emitter voltage +3.6. A technician who was in too much of a hurry might take those readings as being merely on the high side of normal.

Here's the point: we should verify transistor current by measurements of voltage drops across resistances in **both** emitter and collector circuits. Both readings must indicate normal current before you can be sure of correct bias.

To speed up testing of transistor circuits, an ohmmeter with both high-voltage and low-voltage ohms functions is a great help. The high-

voltage type (1.5 volts or more) is used when you **want** to measure the conduction of transistor junctions. Then the low-voltage function (below about .08 volts) is used to measure circuit resistances without the errors caused by conduction of transistors or diodes.

Speaker impedances

If you operate an audio output **tube** without a speaker or other load, nothing much will happen, although I have seen arcs inside the tube or across the socket pins when a pentode without a load was operated with the volume control turned too high. However, the tube suffers no damage.

That's not the case with transistors. Both higher and lower load impedances present dangers. Lower impedances force the transistor to work harder (perhaps exceeding the maximum dissipation), while higher impedances produce dangerously-high transient voltages. Only **one** large voltage spike is required to ruin a transistor.

Although this model Zenith is equipped with a 4-ohm speaker, that's not the case with all brands and models. Others might have speakers rated as high as 40 ohms. Check the specs, or measure the original speaker, so you can avoid using the wrong-impedance test speaker.

Here is a handy rule-of-thumb to determine the impedance of a speaker: measure the DC resistance of the voice coil and multiply it by 5/4. In other words, a 4-ohm speaker might measure around 3.5 ohms, and a 40-ohm one about 35 ohms. While this method is not extremely accurate, it is close enough to prevent any damage to the transistors because of a possible wrong impedance.

Insufficient Vertical Sweep

On the screen of the Zenith 17EC45 solid-state receiver was a horizontal line about a half-inch tall. As shown in Figure 6, the vertical output stage consists of two power transistors in a DC-coupled complementary symmetry circuit. In addition to the usual possibilities in the oscillator, driver and output stages, there are potential sources for losing height in the fuse, set-up

switch, convergence board, and pincushion circuits. Because replacement of the module eliminates all defects on it, we will not dwell on the module circuits, but instead concentrate more on the external wiring.

General information

Several important points should be thoroughly understood before you start servicing this vertical circuit.

If the vertical oscillator (which is separate from the output and driver stages) fails to oscillate, a blanking circuit blacks out the raster. Therefore, for symptoms of normal HV, but no raster, slide the set-up switch to the "set-up" position. The presence of a horizontal line proves the video is blanked, probably because of a vertical oscillator defect.

The old technique used so effectively with tube-powered vertical multivibrators of feeding a 60-Hz sine wave into the various stages to produce some sweep is not recommended for most solid-state circuits.

In this circuit, the first steps of troubleshooting should be to test fuse F203, and to check the waveform at module pins W6 (and W11). If a vertical waveform of more-than-normal amplitude is found there, something must be open in the yoke coils or pincushion circuits.

Don't jumper the fuse

Several unlikely mistakes performed in succession could result in a ruined picture tube or deflection yoke.

Referring to Figure 6, notice that Q708 connects directly to the +35 volt supply, and Q707 is tied to the -35 volt supply. Their respective emitter currents flow through 4.7-ohm resistors to the vertical sweep output terminal at pin 6 of the module. This deflection current flows through the fuse, set-up switch, one yoke coil, the tilt pincushion coil, the pincushion transformer, the other yoke coil, and R203 to ground.

Now, imagine what would happen if either Q708 or Q707 were to develop a collector-to-emitter short. The entire output of one power supply would flow through this low-

resistance path to ground, causing the fuse to blow. There is no vertical sweep, but the receiver is protected from damage. Read on to find out what happens if the fuse is defeated.

A combination of these wrong conditions **could** result in destruction of the picture tube:

- A collector-to-emitter short in either Q708 or Q707;
 - A jumper across F203 used as a test;
 - All screen-grid controls of the picture tube turned high in an effort to show a raster; and
 - Operation for a period of time with the three conditions just listed.
- Obviously, fuse F203 is very important. Replace it **only** with one rated at 600 milliamperes.

Waveform analysis

The waveforms of Figure 6 are normal for this model. At the fuse, the waveshape is a combination, including sawteeth of the deflecting voltage, negative-going pulses produced by the collapse of the yoke field, plus widening at each end of the sawteeth (butterfly wings) caused by the pincushioning action.

At R203, the waveshape is the vertical yoke current, linear sawteeth.

In addition to the main current path through the yoke coils, tilt coil, and pincushion transformer, there are higher-impedance parallel paths through the 220-ohm damping resistors and the two .12 capacitors. Therefore, the exact waveshape produced by an open in the main path depends on where the open occurs. Generally speaking, square waves will be found at W6. That's because there is no current feedback at U4, so gain of the vertical driver increases causing the output transistors to be overdriven.

Remember the original complaint was a picture only about a half-inch tall. The two waveforms were similar to those described in the preceding paragraph, indicating an open. Several ohmmeter tests showed that the tilt coil was open. A fast test for open pincushion components is to place jumpers across both the .12 capacitors. Full height is proof of an open in L1301 or T1301.

(Continued on page 57)

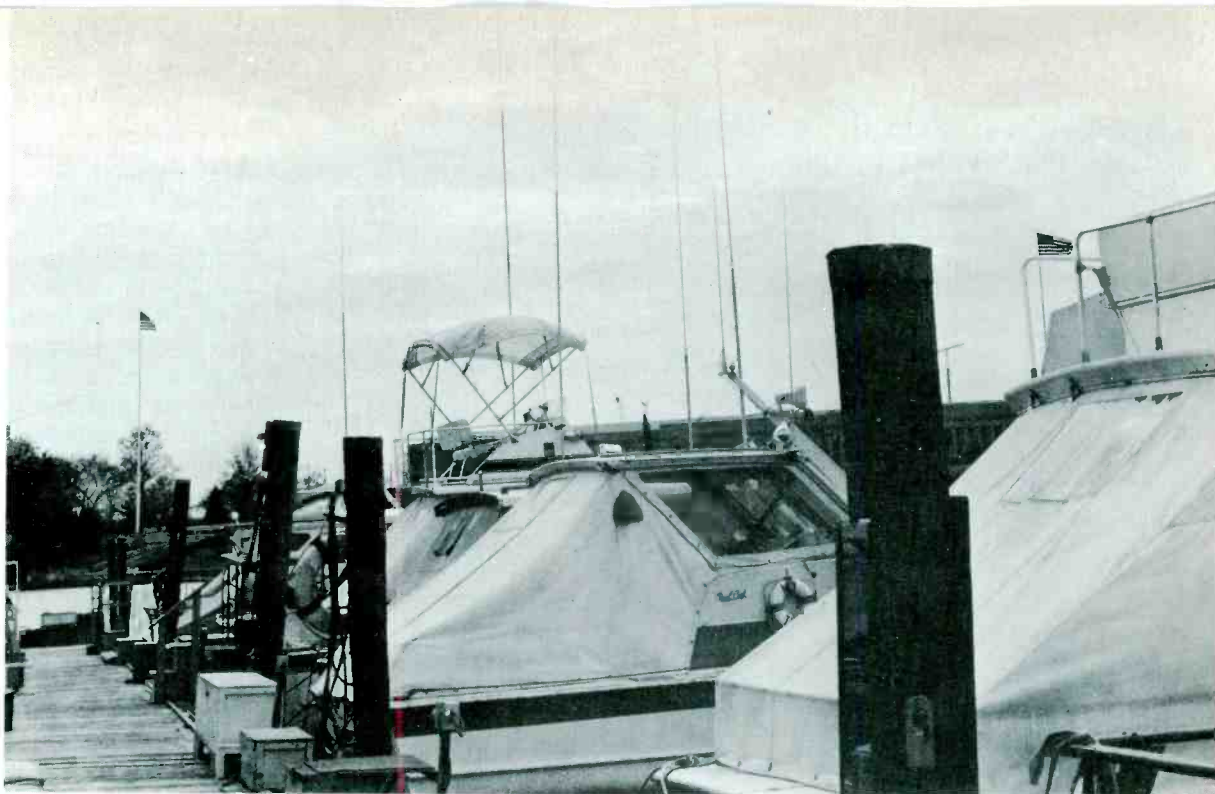

The forest of boat radio antennas found at any dock or marina is proof that repairs of marine radios are badly needed.

CIRCUITS AND REPAIRS OF MARINE RADIO

By Joseph J. Carr, CET



Boat owners in many parts of the country complain that service for their marine radio equipment either is slow or not available. If you could use extra business during the summer months, servicing marine radios might be the answer. Here's the information you need to get started.

Originally, the Federal Communications Commission (FCC) allocated part of the frequency spectrum between 2 and 3 MHz for use by marine two-way radios. Modulation was by Single Sideband (SSB), a specialized form of amplitude modulation. However, signals of such low frequencies traveled so far that interference became nearly intolerable. The FCC decreed a move to the VHF bands, to be spread over a period of several years.

For a time after the change, only those boat owners having a licensed VHF-FM rig could obtain a license

for the 2-3 MHz SSB radio equipment. The idea was for the VHF-FM band to be used for river, lake, and other short distance communications, while the longer-range SSB radio was reserved for vessels operating offshore. At this time, no new licenses for the 2-3 MHz band are being issued. Therefore, the equipment for the VHF-FM band is the type to be discussed.

Frequencies

All new VHF-FM radios are required to operate on at least three channels. Two of these are 156.30 MHz Channel 06 (safety for ship-to-ship), and 156.80 MHz Channel 16 (safety and calling for both ship-to-ship and ship-to-shore). The third channel is owner's choice, and the best one will depend on local conditions and the owner's activities.

A Typical Transceiver

A typical marine VHF-FM two-way radio is the Simpson Model-B (Figure 1). Receiving functions are



Fig. 1 Typical of marine radios is the Simpson Model-B.
(Photo courtesy of Simpson)

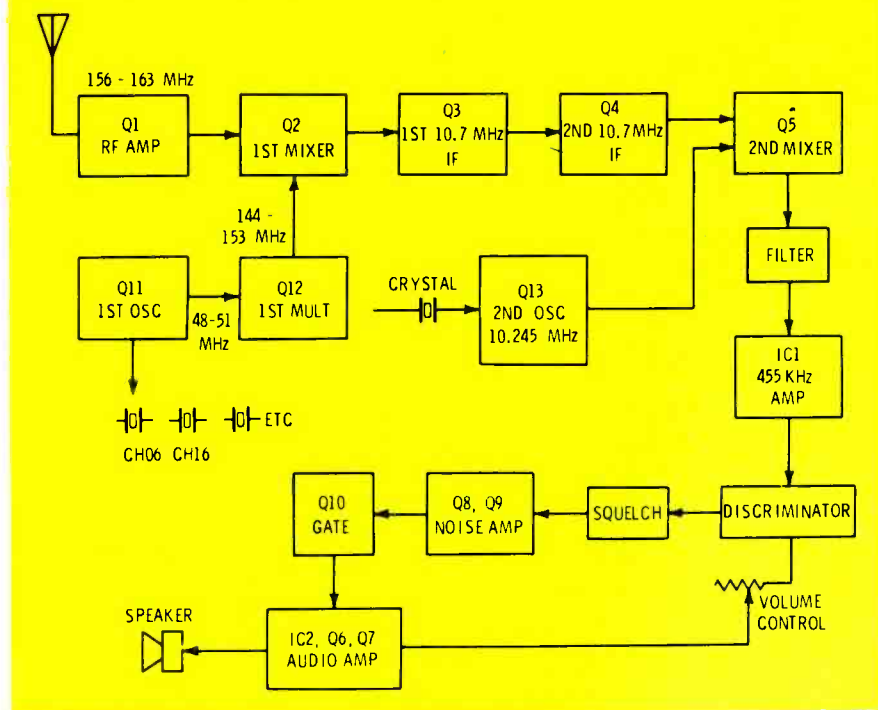

Fig. 2 Block diagram of the receiving function of the Simpson Model-B shows the stages and frequencies of the double-conversion design.

shown in the block diagram of Figure 2. In basic type, it is a double-conversion superheterodyne receiver.

Input signals of the 156-163 MHz band are heterodyned by the first oscillator and the first mixer to create an IF of 10.7 MHz. Such a high intermediate frequency doesn't give much selectivity or gain, but it does minimize images.

Generally speaking, it's common for tripling of the frequency to be done in the oscillator. Although crystal oscillators can be built to operate in the fundamental mode at the required 144-153 MHz frequencies, the quartz crystal becomes too thin for accurate grinding, and it is very fragile. Therefore, in the Simpson radio, tripling is accomplished in the Q12 1st multiplier.

Following two stages of amplification, the 10.7 MHz IF signal and the output of a fixed-frequency crystal-controlled 10.245 MHz oscillator are injected into the second mixer to produce an IF of 455 KHz.

Most of the gain and selectivity is obtained in the IC1 455 KHz IF stage. That's because (all other factors being equal) selectivity is a percentage of the frequency. Therefore, the lower the frequency, the sharper the selectivity.

Other IF systems

Many ingenious circuits have been tried to improve the IF selectivity over that possible with simple tuned circuits. Such innovations as discrete crystal lattices, or multipole LC filters operate fine, but carry a high price tag. One excellent compromise between cost and performance is found in the ceramic-mechanical bandpass filter (described in the Delco car radio article in the June issue).

Next, the signal is applied to the discriminator. But we should discuss first the type of modulation and how it differs from AM.

FM Versus Phase Shift

In all frequency-modulated transmitters, the audio signal from the microphone is used to vary the frequency of the carrier. Actually, there are two forms of FM: "pure" frequency modulation, and phase modulation (PM). In practice, FM provides a large change of carrier frequency, while PM produces a narrow range of frequency shift.

If an RF carrier permanently is changed in phase, it will measure the same frequency both before and after the change. By comparison, an RF carrier that permanently is changed in frequency will measure a different frequency after the

change. However, it is important to know that a signal having a rapidly-varying phase has most characteristics of a true FM carrier, and it can be handled in similar circuits.

Proof from the musical world is found in the vibrato (frequency change) used in those Hammond Organs that produce sine waves by magnetic tone wheels. The music is introduced into a series of LC filters, then the sounds are picked up by a scanner which (in effect) gradually moves down and back the series of phase-shifting filters. When the scanning proceeds from the source to the far end of the filters, the pitch sounds flat (lower pitch because of progressively-lagging phase). And when the scanning is from the far end towards the source, the apparent frequency is sharp (higher pitch because of leading phase). Human ears believe the pitch alternately is going flat and sharp around the correct center frequency. Actually, the frequencies are always the same, but the phase is changing rapidly.

FM Discriminators

Audio detectors in FM equipment are called "discriminators", and they respond to a change of signal phase, regardless of whether the phase change is caused by a shift of frequency or of phase. The audio output signal from a discriminator is a DC voltage which varies in amplitude and polarity according to the change of input-signal phase. In addition, there is another DC voltage (sometimes used for AGC or signal-strength meters) that changes according to the amplitude of the carrier. This is the voltage that actuates the squelch in two-way radios.

In turn, the squelch circuit either blocks or permits passage of the audio signal through the audio stages to the speaker.

Transmitting Circuits

Internal relays select either the receiving or transmitting function. During transmissions, an audio voltage is generated by the operator talking into a microphone (Figure 3). This signal is amplified by transistor Q8, and then limited in amplitude by a clipper/filter stage.

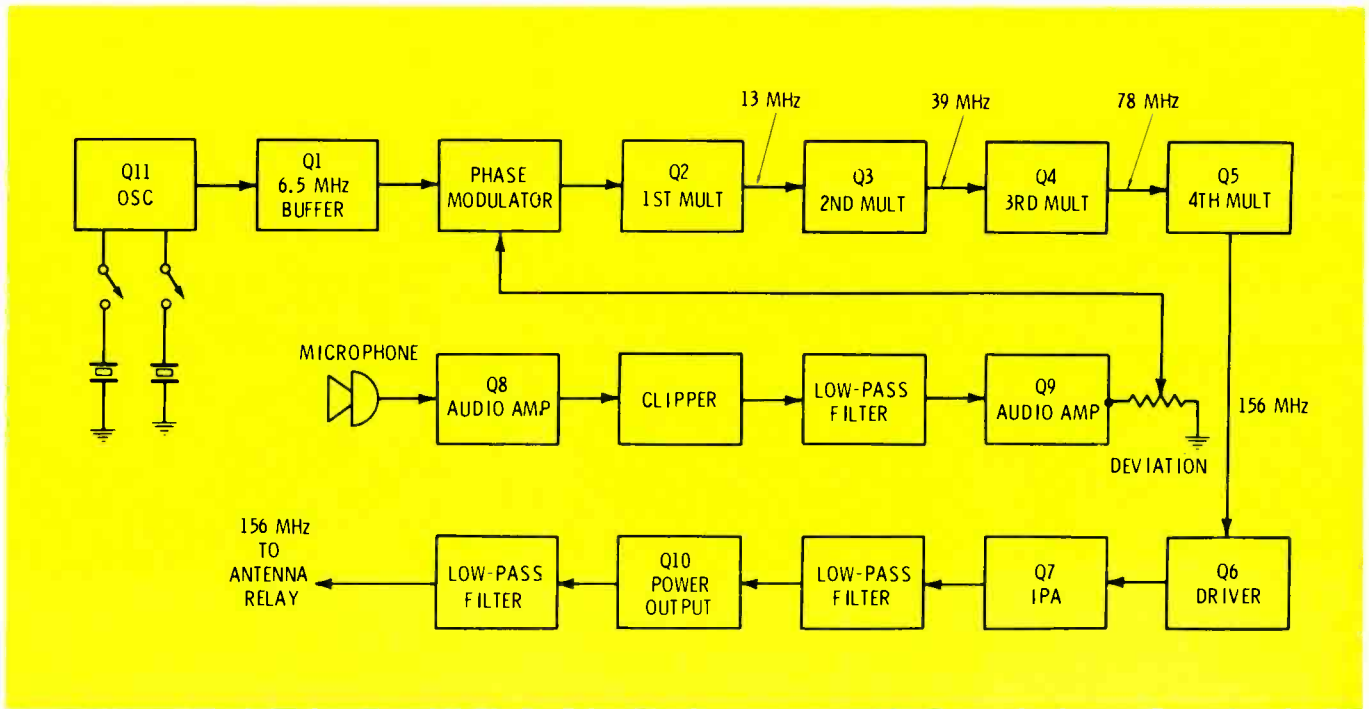

Fig. 3 Block diagram of the Model-B when transmitting.

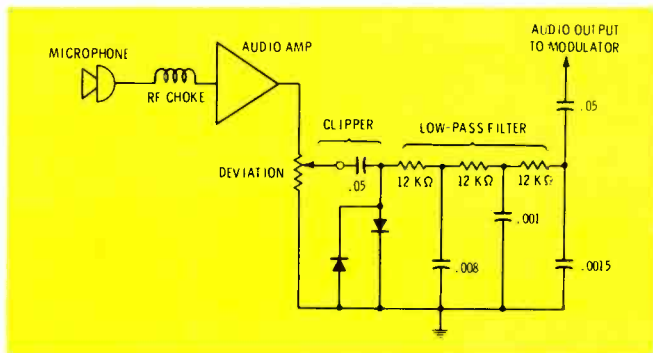

Fig. 4 Schematic of one type of clipper and bandpass filter. The clipper keeps the average modulation high without danger of overmodulation, and the low-pass filter minimizes distortion caused by the clipping.

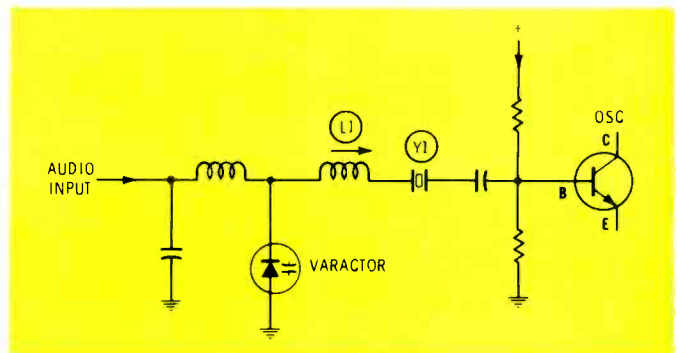

Fig. 5 One direct way to obtain FM modulation is for the audio to change the capacitance of a varactor diode, which in turn changes the frequency of a crystal oscillator.

Clipping permits full modulation at all times.

A typical clipper/filter stage is shown in Figure 4. The paralleled front-to-back diodes clip both positive and negative peaks of the audio signal, making square waves. At first glance, it would seem the diodes would eliminate all signal. One shorts out the positive, and the other the negative. But diodes don't conduct until the forward bias is nearly .7 volt. Therefore, an audio voltage of about 1.4 volts p-p remains.

Bandpass response (attenuation of both higher and lower frequencies) is provided by the values of resistors and capacitors. Low-frequency noises are reduced by the

first .05 coupling capacitor. Although that value seems adequate for good bass response, it's not in this circuit, for the impedance of the two diodes is only a few thousand ohms.

High frequencies are reduced drastically by the three-section low-pass filter following the diodes. Some improvement of the signal-to-noise ratio results from the filtering. But the main reason for the strong filter is to reduce splatter and distortion. Clipping of the audio signal generates intolerable amounts of raspy-sounding distortion. That's because clipping adds high frequencies not present in the original audio. Rolloff of response by the filters rounds the corners of the

waveforms, making the sound more natural and with less apparent distortion.

Deviation control

If the "deviation" control of Figure 3 looks suspiciously like a volume control, there's a good reason; that's just what it is. However, the name comes from the amount of phase shift (deviation) determined by adjustment of the control.

Modulating a crystal oscillator

A varactor diode can be used to frequency modulate a crystal oscillator (Figure 5). Audio causes the varactor to change capacitance, which forces the oscillator to change

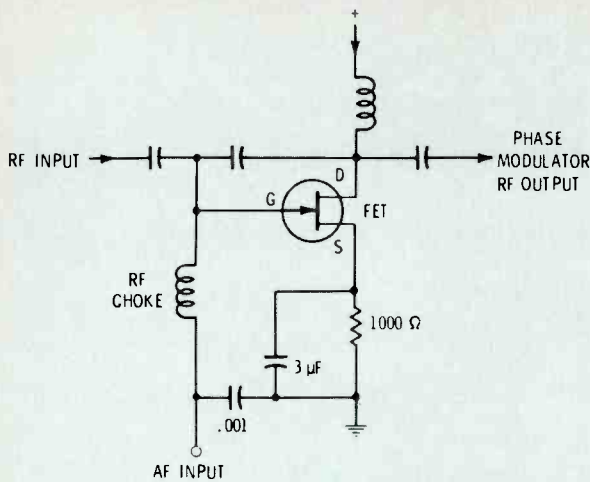

Fig. 6 Phase modulation of an RF carrier can be done in a reactance stage, such as this FET circuit, where direct signals and phase-inverted signals are mixed to produce different phases.

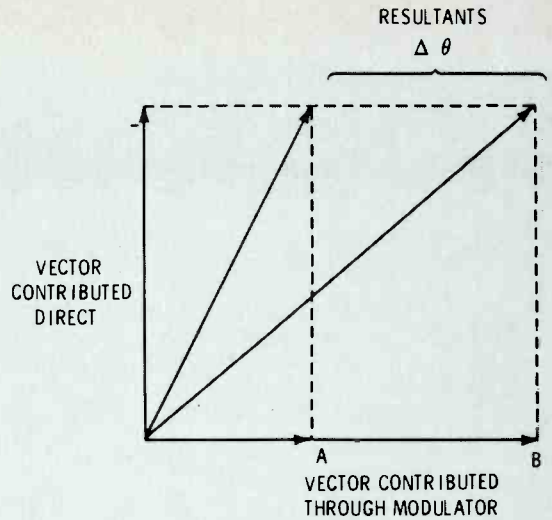

Fig. 7 This vector (phasor) diagram shows how two branches of a signal having different phases combine to give resultant phases.

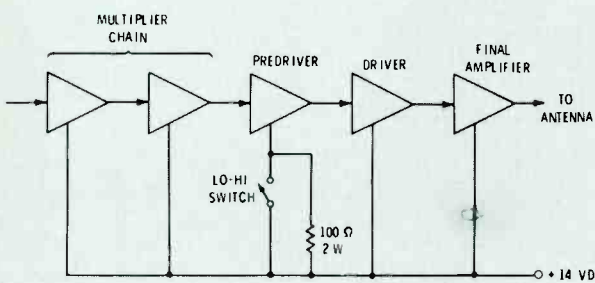

Fig. 8 All VHF-FM transmitters must have a means of reducing the output power to less than one watt. One simple way with transistors is to reduce the collector supply voltage of a driver transistor.

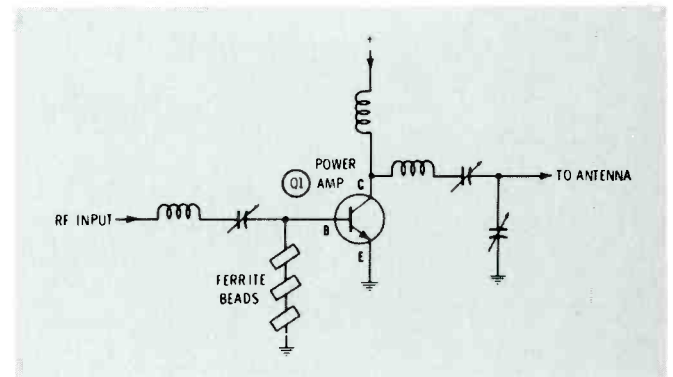

Fig. 9 Ferrite beads strung on a wire act as an RF choke, giving high impedance to RF and low resistance to DC. Current from the RF drive signal at the base provides forward bias to produce collector current.

frequency. Only a small change of frequency is possible, because crystal oscillators are very stable.

Another method of modulating any low-level RF signal is shown in Figure 6. At the drain, two signals are combined. One is the direct signal, coming through the gate/drain capacitor; the other is the phase-inverted signal produced by amplification in the FET (see Figure 7 for the vector analysis). Gain of the FET is changed by the audio signal; therefore, the phase of the output signal is changed also.

Transmitter Oscillator

According to the FCC rules, the transmitter frequency should be accurate within .001%. It is far easier to obtain the exact frequency with good stability at the lower-fre-

quency ranges. Therefore, the Simpson (Figure 3) operates the oscillator in the 6.5 MHz range. A buffer (Q1) isolates the oscillator to enhance the stability; then the output of the buffer and the audio are applied to the phase modulator.

Although the phase modulator does not shift the phase by any large amount, the frequency is multiplied by 24 in the following stages, and the deviation is multiplied also by the same factor or 24.

Multipliers are amplifiers that are overdriven to produce strong harmonics (distortion). Then the tuned circuit in the output resonates at the desired harmonic, eliminating most of the original fundamental and other harmonics. Higher harmonics have less amplitude than the lower ones, so usually

the second (doubler) or the third (tripler) are used.

Reduced Power

Regulations call for the maximum power output to be reduced to under one watt while the craft is in harbor. One of the most simple ways of doing this is to reduce the collector DC voltage of a driver stage (Figure 8). Although the reduced drive might cause a tube to be ruined because of excessive dissipation, transistors merely draw less current when the drive is reduced.

Power-Output Stages

Some of the greatest advances of technology have occurred in the RF power-output stages of mobile radios. Until recent years, the VHF

transistors suffered from low power, low gain, uncertain reliability, and high prices. For example, one such replacement transistor cost more than \$165! All these shortcomings have virtually been eliminated in the modern transistors.

Two features make the circuit of Figure 9 of interest. Both are in the base circuit of Q1. There is no apparent source of the positive voltage required for forward base bias. If there were no driving RF signal, there would be no bias and no transistor current. But the RF from the driver stage is sufficient to cause base current to flow during about half of each sine wave. In other words, the transistor is operated in class "B".

Older transmitters used an RF choke between grid and ground (or bias). Loss of drive was prevented by the high impedance, and the low resistance minimized DC voltage drop. However, RF chokes have too much stray capacitance for effective use at VHF frequencies. Also, RF chokes suffer from self-resonance, in which the inductance and stray capacitance of the windings resonate at an undesired frequency.

One simple and effective solution in transistor circuits is to slip a few ferrite beads over a piece of wire. The beads cause the wire to have inductance, but without the self-resonance of discrete RF chokes. That's why the base signal of Figure 9 is not shorted to ground; the beads add inductance, and the wire keeps the DC resistance low.

Licenses

At least a Second-Class Radiotelephone License is required before you can make internal adjustments affecting the performance of the transmitter, change crystals, or certify the operating parameters. However, several other technicians can operate under the supervision of one license-holder.

Equipment

When I was a junior-apprentice-assistant technician (that is, "go-pher" or "hey, boy"), I worked in a shop which had some marine-radio trade. Our test equipment included a WW-II surplus BC-221 hetero-

dine frequency meter, a VOM, a home-brew crystal oscillator (for receiver alignment), and a beat-up Hammarlund Super-Pro receiver. Don't laugh; we made money. All this equipment cost less than \$500.

Don't expect to get by with such simple equipment today. Because of the higher frequency and stricter tolerances of the VHF band, it is imperative all equipment have better accuracy.

For example, heterodyne frequency meters are obsolete. Instead, frequency counters of an accuracy five times that required of the transmitters measure the frequency by actually counting the cycles for a fairly long period of time. At 156.3 MHz, the accuracy must be within ± 1563 Hz!

Deviation meters and RF-power meters also are coming down in price. Right now is a good time to purchase the specialized generators and equipment necessary to service CB or marine radio transceivers.

ZODIAC DISTRIBUTORS

RT. 31 BOX 96 LEBANON, N.J. 08833
(201) 735-5222

ONE STOP PARTS WAREHOUSE

All Parts Shipped Same
Day At Our Expense

AUTHORIZED DISTRIBUTOR FOR:

AMPEREX	ONEIDA
ANTENNA	PANASONIC
SPECIALISTS	PHILCO
ARVIN	RCA
BOMAR	H. W. SAMS
BRADFORD	SBE
CTS SPEAKERS	SHARP
ELECTROPHONIC	SOUNDESIGN
EV/GAME	TENNA
GAVIN	TOYO
HITACHI	TRIAD
LLOYDS	TRANSFORMERS
MAGNAVOX	TRW CONTROLS
MALLORY	WORKMAN
MARDEN	ZENITH

REGULAR SPECIALS

80% OFF ON PHONO NEEDLES
65% OFF ON TUBES (NEXT DAY DELIVERY)
50% OFF ON SEMICONDUCTORS
ANY 5 FLYBACKS FOR \$60.00
6GH8A TUBE \$.80 EACH
6LQ6 TUBE \$3.21 EACH
SBE 8 CHANNEL HILO SCANNER
\$122.00 (AC-DC CRYSTALS EXTRA)

ORDERS PHONED IN BEFORE 12:00 NOON
WILL BE SHIPPED SAME DAY...RECEIVED
NEXT DAY WITHIN ZONE 2 U.P.S.

\$5.00 MINIMUM ORDER

OPEN ACCOUNTS WELCOMED

For More Details Circle (13) on Reply Card

BOTTOMS UP



Start saving the gray bottom flaps with the GE monogram from GE entertainment receiving tube cartons. They're worth valuable awards to independent service dealers and technicians in a fabulous gift bonanza program from General Electric.

The gift list includes some 43 items ranging from sporting equipment to home appliances, from diamond jewelry

to distinctive luggage, from globes and books to calculators and Attend-a-Phones. It even includes the much prized Polaroid SX-70 camera and American Experience weekend vacations at any one of 101 prestigious resorts.

BOTTOMS UP!!! Redeem your flaps by November 30, 1974. Full details at your authorized distributor.

TUBE PRODUCTS DEPARTMENT
GENERAL ELECTRIC COMPANY
OWENSBORO, KENTUCKY 42301

GENERAL  ELECTRIC

Fun Around OHM

Even though you know electronics from E to S, this Pinwheel Puzzle is guaranteed to have you going around in circles! The last letter of each word is the first letter of the next word. Each correct answer is worth 5 points; a perfect score is 115. It should be easy to get a high rating except perhaps for someone who thinks "blue prints" is a nobleman wearing a tight shirt collar, or that "detent" is an important item when camping!

by Edmund A. Braun

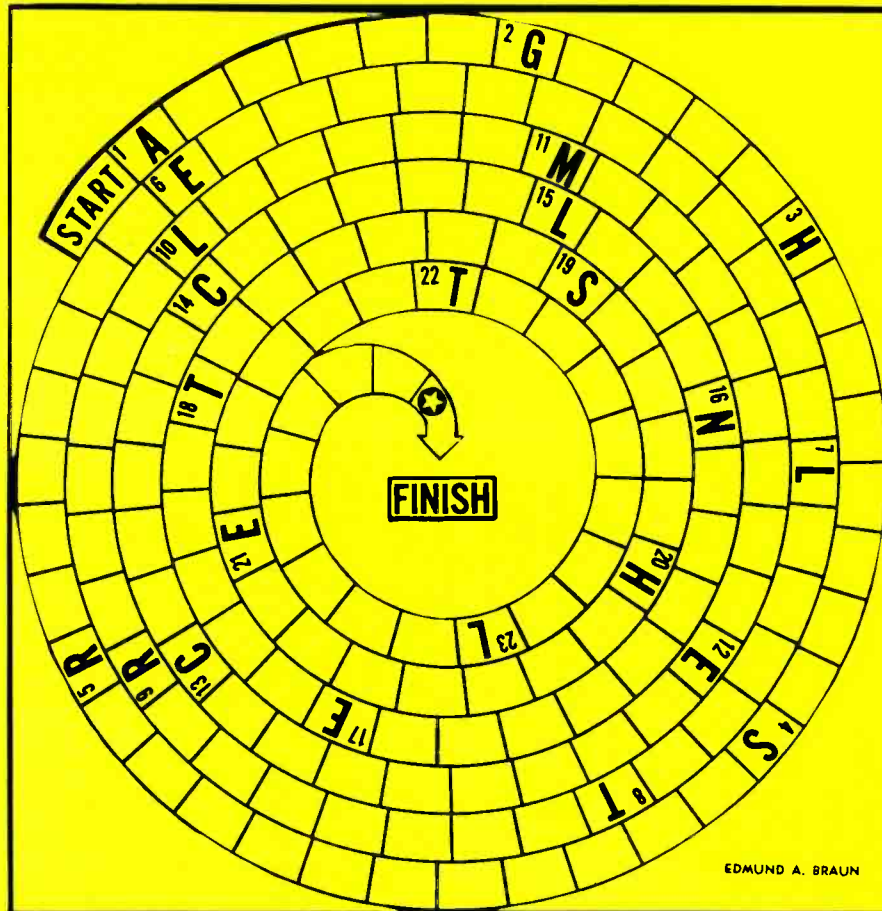

EDMUND A. BRAUN

- | | | |
|--|---|---|
| <ol style="list-style-type: none"> 1. Conductive graphite coating used in and on a CRT. 2. Low frequency video interference. 3. Sinusoidal waves with frequencies that are multiples of fundamental waves. 4. Material having less resistance than an insulator but more than metal. 5. Opposition to the flow of AC. 6. Heating aspect of an electric current. 7. Unit of luminance. 8. Non-vacuum device similar in purpose to an electron tube. 9. Pertaining to charge on capacitor plates after initial discharge. 10. Alkaline metal used in | <ol style="list-style-type: none"> 11. Pertaining to black and white television. 12. A type of circuit. 13. Clay-like substance which, after processing, is used as insulation. 14. Type of transmission line not susceptible to external fields. 15. System used by ships and aircraft to fix their positions. 16. Amplifier circuit used in early tuned-radio-frequency receivers. 17. Any component of a vacuum tube. 18. Four-electrode | <ol style="list-style-type: none"> 19. vacuum tubes. 20. Device for controlling current. 21. Ionospheric layer that reflects radio-waves back to earth. 22. Removes unwanted portion of a printed circuit during fabrication. 23. Doughnut or ring-shaped. 24. Straight line response to an input signal. |
|--|---|---|

We know you wouldn't sneak a peek so we'll tell you frankly, the solution is on page 57.

test equipment report

These features supplied by the manufacturers are listed at no-charge to them as a service to our readers.

If you want factory bulletins, circle the corresponding number on the Reply Card and mail it to us.

Generators

Two basic function generators are available from **Tucker Electronics Company**.

Model 300A is a 0.1 Hz to 1 MHz generator offering 10V p-p output into 50 ohms and less than 2% sinewave distortion. The 300A provides sinusoidal, square and triangular wave switched outputs and a corresponding sync output. DC offset of ± 2.5 volts is standard. The generator is portable and designed to operate either in an 8 X 5 X 8-inch lab model or as a standard half rack panel mount. Model 300A sells for \$225.00

Model 310A adds variable pulse to the basic functions. TTL compatible



pulse can be varied from 1 us to 10 ms pulse width and has rise and fall times exceeding 25 ns. It sells for \$295.00.

For More Details Circle (30) on Reply Card

Digital Multimeter

Model 2110 3-1/2 digit, bi-polar, portable multimeter has been introduced by **Digitec**.

DC ranges extend from 199.9 mV full scale to 1000 volts with a basic accuracy of 0.1% of reading; AC voltages can be measured from 1.999 volts full scale to 500 volts with an accuracy of 0.5%; resistance ranges extend from 199.9 ohms full scale to 19.99 megohms with an accuracy of 0.5%.

All printed circuit boards, integrated circuits, and readouts are plug-in for easy replacement. Internal rechargeable batteries can be installed for portable operation, and a built-in automatic recharger will maintain batteries at full charge as long as the instrument is connected to the power line.

Model 2110 sells for \$219.00.

For More Details Circle (31) on Reply Card

Low-Profile VOM

A low-profile volt-ohm-milliammeter designed primarily for bench and shop use is offered by **RCA Electronic Components**.

The RCA WV-536A features a recessed taut-band meter and a plastic case which will withstand rigorous use in schools, industry, and shops. The VOM has meter scales and panel

markings coded in three corresponding colors for easy range-function identification, a zero-center-scale adjustment, and a front-panel polarity-reversing switch that changes input polarity on DC functions.

Model WV-536A has a DC input resistance of 30,000 ohms per volt, and will measure DC voltage up to 2500 volts, AC up to 1000 volts, and direct current from 5 μ A to 5 amps full-scale. Resistance is measured in three ranges.

The VOM sells for \$48.00, complete with instructions and test leads.

For More Details Circle (32) on Reply Card

Tube/Transistor Tester

The TC28 Hybrider from **Sencore** provides the technician with a simplified unit for testing transistors or tubes. A combination of the Sencore Mighty Mite and Cricket models, the Hybrider is a tube tester on the left and a transistor tester on the right.

Layout is simplified beyond the two separate units by running the outputs into a common meter. Everything can be read on one large meter, and the customer can see the defect too. A tube chart is included for the tubes; the transistor tester does not require set-up charts.

The TC28 Hybrider sells for \$220.00.

For More Details Circle (35) on Reply Card

Counter/Timer

Autometronic Model 5500A auto-ranging counter/timer from **Ballantine Laboratories** can autorange time interval as well as frequency measurements. It is said to be the first small, portable counter capable of autoranging on a single time interval.

The Autometronic circuit utilizes a "Read Only Memory", allowing time and frequency measurements to be made without operator adjustments. Model 5500A can measure to 90 MHz; it has ten operating modes and a test mode. Resolution is selectable in 4, 5, 6, 7, or 8 digits. The counter has DC coupled inputs on both channels, over-voltage protection and input filters for noisy signals.

Model 5500A sells for \$650.00.

For More Details Circle (33) on Reply Card

5-inch Scope

Simpson Electric Company has introduced a 5-inch oscilloscope Model 455 with 10-MHz bandwidth and 10 mV/CM vertical sensitivity.

The scope accepts camera or light hood, and has a low parallax, high-contrast graticule with both amplitude and vector display index. Recurrent sweep frequency is adjustable from 1 Hz to 200 KHz, in 5 overlapping ranges. For TV work there is a special sweep rate for horizontal sync, and R-Y/B-Y inputs for vector alignment. Horizontal sensitivity is 300 mV/CM with bandwidth from DC to 500 KHz.

Vertical sensitivity is continuously variable through nine calibrated steps from 10 mV/CM to 5 mV/CM ($\pm 3\%$); bandwidth is DC to 10 MHz. A 1 KHz, 500 V peak-to-peak square wave signal is provided for external circuit testing and voltage calibration.

The Simpson Model 455 oscilloscope is priced at \$295.00.

For More Details Circle (34) on Reply Card



Get Less For Your Money.

Yes, we said less. HP's 3 1/2-digit probe multimeter gives you less of the things you'd rather do without. Less worry about knob settings because this unique digital multimeter has AUTO ranging, AUTO zeroing and AUTO polarity. Less weight and bulk... at a scant seven ounces including a rechargeable NiCad* battery, it's fully self-contained and fits in the palm of your hand. Less chance for error because the easy-to-read digital readout is right at the test point. This easy-to-use probe multimeter is so advanced that it's practically fool-proof... yet it costs only \$310*. But get the full story on all the features and benefits you *do* get from HP's 970A probe multimeter... and from its companion scope mentioned elsewhere on this page.

*Domestic U.S.A. price only.

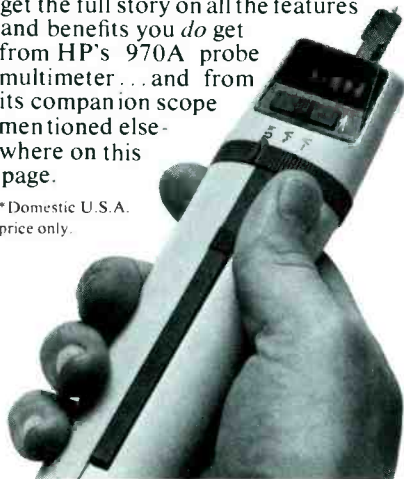

HEWLETT  PACKARD

Sales and service from 172 offices in 65 countries.
1501 Page Mill Road, Palo Alto, California 94306

Tell me more about your
 probe multimeter, scope.

Name _____
Dept. _____
Company _____
Address _____
City _____
State _____ Zip _____

Hewlett-Packard Co.
1501 Page Mill Rd.
Palo Alto, California 94306 ES71/174

For More Details Circle (14) on Reply Card

productreport

for further information on any of the following items, circle the associated number on the reader service card.

Aerosol Service Chemicals

GC Electronics offers four aerosol chemicals—Formula 70, Tuner Bath, Super Freeze Mist, and Magic Vista. Available in 3-ounce cans, the chemicals are convenient and easy to use. Super Freeze Mist, Magic Vista, and Tuner Bath are also offered in a space-saving leatherette pouch. The Caddy Kit supplies the necessary chemicals to cool circuits or clean and degrease tuners.

For More Details Circle (36) on Reply Card



Parts Cases

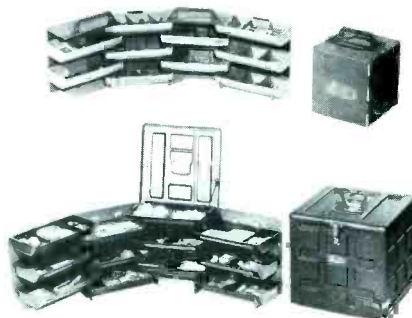

Two folding parts cases for use in the shop or on service calls are available from **General Electric**.

Model ETRS-5980, a small, compact case, provides adequate space for

hundreds of resistors, capacitors, semiconductors and other service parts. It features more than 500 cubic inches of storage space and has ten trays that can be divided into three sections each by using the 20 dividers supplied with each unit. When closed, the polystyrene case forms an eight-cubic-inch square. Model ETRS-5980 sells for \$5.95.

Model ETRS-5981 is a larger, heavy-duty case featuring 12 trays which can be divided into four sections each. Made of high impact plastic, the case is useful for storing UHF tuners, capacitor cans, and small transformers. When closed, it measures 12 X 12 X 11-1/2 inches and sells for \$29.95.

For More Details Circle (37) on Reply Card

Alarm System

Idea Systems, Inc. announces the availability of Model Y-1000-A burglar and fire alarm system. When an intrusion is attempted, the magnetic closure contacts are latched, sounding the piercing alarm siren. There is also a special circuit for fire detection which sounds the siren if the temperature exceeds sensor limits of 135°F.

Model Y-1000-A is packaged in kit form and can be installed without special tools. The kit includes a heavy-duty speaker horn, solid-state control center, two 6-volt batteries, security shunt lock with two keys, package of mounting hardware, door or window decal, 150 feet of black and yellow conductor wire, two magnetic switches, two 135° fire sensor

switches, and complete instructions. The system has built-in test equipment and operates on 12-volts DC.

Model Y-1000-A sells for \$89.95.

For More Details Circle (38) on Reply Card

Transmitter Analyzer

The Trans-A-Lizer from **Transel Corporation** is designed to monitor the output signal of marine, amateur, or CB transmitters (AM-SSB) between 3 to 30 MHz. The unit is an inline type (50-ohm coaxial cable) and is used with transmitters in the 2 to 2000 watt output range.

For convenience, the 80-10/11 meter bands are indicated on the front panel. There are two direct-reading displays: a 3-1/2-inch peak-reading

ELECTRONIC SERVICING

wattmeter and a 3-inch scope that indicates the percentage of modulation. The unit shows both positive and negative peaks in an envelope pattern.

The Trans-A-Lyzer sells for \$149.95.

For More Details Circle (39) on Reply Card

Parts Catalog

The 1974-75 VHF-UHF-FM Tuner Replacement Guide and Parts Catalog No. 4 is available from **PTS Electronics, Inc.** The catalog illustrates thousands of parts for all kinds of tuners and includes the complete line of PTS test equipment, tools and chemicals. The catalog sells for \$2.00, which is refundable with a first order for goods or services.

For More Details Circle (40) on Reply Card

Module Caddy

RCA Parts and Accessories has a new color TV module caddy which comes with one each of the 12 most frequently used RCA modules. The technician can carry a larger selection of the modules needed to service RCA modular TV chassis.



Featuring twice the capacity of the former RCA caddy, the new model has storage space in the bottom and in the lid for extra modules, tools, and service data. Number 199003 module caddy sells for \$118.00, with a full complement of modules.

For More Details Circle (41) on Reply Card

Heat Sink Compound

SL-1 silicone heat-sink compound from **Chemtronics** is designed for use on solid-state electronic equipment; it is suitable for heat-transfer applications and for mounting power transistors.

The compound features good thermal conductivity, high dielectric strength, low dissipation factor and good storage stability; it can withstand temperatures between -65 and +400°F.

SL-1 is available in one-ounce squeeze tubes mounted on pegboard display cards and sells for \$2.15.

For More Details Circle (42) on Reply Card

Security Systems

PLC Electronics Inc. announces the availability of No. 700 single door security system, one of 17 packaged systems designed for installation by professionals in the electronics field.



Everything needed is in one package, including illustrated detailed installation instructions. A catalog and dealer price list can be obtained by including your business letterhead with the Reader Service Card.

For More Details Circle (43) on Reply Card

Products Catalog

A revised 36-page commercial products catalog No. 110 is offered by **Winegard Company**.

The catalog contains illustrations, descriptions, and specifications for over 250 products, including Ultra-Plex strip amplifiers, power panels, splitters, drop taps, line amplifiers, and tilt compensators. Commercial systems equipment for MATV, CCTV, ITV, ETC, CATV, NATV and sub-channel are also listed.

The catalog costs 25 cents.

For More Details Circle (44) on Reply Card

ELECTRONIC SERVICING

is your magazine!

If you would like to see an article about a particular subject directly related to servicing consumer or communications electronic products, send us your suggestion.

We value your comments and criticism.—Ed.

Get Less For Your Money.



Less reason for those squinting, guessing, knob-twisting measurements with HP's bright, full 5-inch diagonal display. Choose HP's new dual-channel, 15 MHz scope and you'll get all the sensitivity, accuracy and big-scope conveniences you're likely to need. That means less wasted time because the scope is so easy to use. Less weight lifting because it checks out at a mere 15 pounds. And less downtime because the scope meets HP's most rigorous quality standards—and it's backed by HP's worldwide service and support organization. Best of all, it costs less—much, much less—than you might think. Just \$695*. Get all the information on this great buy—and on HP's revolutionary new probe multimeter discussed elsewhere on this page. Send in the coupon today.

*Domestic U.S.A. price only.



Sales and service from 172 offices in 65 countries.
1501 Page Mill Road, Palo Alto, California 94306

OR 472

Tell me more about your

scope, probe multimeter.

Name _____

Dept. _____

Company _____

Address _____

City _____

State _____ Zip _____

Hewlett-Packard Co.
1501 Page Mill Rd.
Palo Alto, California 94306 ES7/1/74

For More Details Circle (15) on Reply Card

audio systems report

These features supplied by the manufacturers are listed at no-charge to them as a service to our readers.

If you want factory bulletins, circle the corresponding number on the Reply Card and mail it to us.

Acoustic-Suspension Speakers

Utah Electronics is featuring a compact acoustic-suspension system, the AS-2AX, with an unusually flat impedance curve. Utah engineers say this makes the AS-2AX safe for parallel hook-up to solid-state amplifiers. The impedance is 11 ohms at resonance, and dips to only 6.7 ohms at its lowest point.

Bass response is down to 45 Hz from the 8-inch woofer, which has damped-fabric suspension and a 1-1/4-pound magnet assembly. Highs out to beyond audibility come from the sealed-chassis 3-1/2-inch direct-radiator tweeter. The drivers and their 5

KHz crossover are enclosed in a walnut-veneer cabinet. Other features include a rated response of 45-17,500 Hz, power capacity of 24 watts peak audio, and impedance of 8 ohms; the system measures 11-1/4 X 17-1/4 X 8-1/4 inches.

AS-2AX acoustic-suspension system sells for \$49.95.

For More Details Circle (45) on Reply Card

Needle Lock

A protection device for diamond needles while on display in stereo phonographs has been developed by Se-Kure Controls, Inc.



The diamond needle lock protects the cartridge from theft and makes a turntable ready for immediate demonstration, saving the employee time and lost sales. The unit is constructed of heavy, durable plastic and features a multi-combination key lock. Designed to fit most tone arms, it can be installed quickly and easily, and requires no special tools.

The diamond needle lock sells for \$4.00.

For More Details Circle (46) on Reply Card

For More Information
On Items Advertised
Use Our
Reader Service Cards

Remote Speaker System

Magnavox has introduced a remote speaker system that is only 3 inches deep, but is said to deliver fine sound reproduction. The Thinline remote speaker system can be used with stereo consoles as remote units or used with a tuner/amplifier and record changer to complete a stereo system. The units can also be utilized with consoles or components equipped with four-channel sound decoder to make up a four-channel system.

Two tweeters are angled out the front to give greater dispersion of high frequencies and one tweeter faces out the back for bi-directional sound. A three-position level control enables the listener to adjust for proper listening balance when the Thinline speakers are used with other systems. Each speaker measures 25-1/2 X 18 X 3 inches; each base measures 15 X 10 inches. Functional as well as decorative, the speakers can be wall mounted.

The Thinline remote speaker system sells for \$149.95.

For More Details Circle (47) on Reply Card

cartoon corner



"I assume you've brought work here before?"

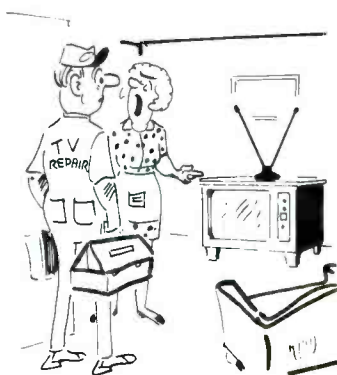

"I think the rabbit ears went deaf—the sound is gone!"

NEW FINCO Greenline

VOM MULTITESTER

16 RANGE, 20,000 OHMS/VOLT



MODEL
31201



Back View

THE BIGGEST SELLER with a unique, heavy, Rubber Molded, Form-fitted BUMPER CASE!

FEATURES:

- 20,000 OHMS/Volt DC; 10,000 OHMS/Volt AC
 - 1 year guarantee
 - ± 1% resistors for high accuracy
 - Meter overload protection
 - Double-jeweled ± 2% meter
 - 16 excellent ranges
 - Off range which shunts meter during transportation
 - Heavy rubber molded, form fitted, bumper carrying case, offering maximum protection with handy test lead compartment
 - 28 ohm center scale for low ohms requirements
- FINCO, the Champion of all Electronic Independent Service!*

Write for Catalog 20-647; Dept. ES-7-74

The FINNEY Co.
34 West Interstate Street
Bedford, Ohio 44146

For More Details Circle (23) on Reply Card

Microphone Mixer

Designed to increase the number of microphone inputs to tape recorders or amplifiers, the Mike Mixer, catalog number 30-2320, features transistorized circuitry, standard 1/4-inch phone-jack inputs and outputs, and stereo/mono and on/off switches.

The Mike Mixer from GC Electronics feeds up to four high-impedance signals to a single high-impedance input. With its separate volume controls, it is possible to increase the volume of any channel, while feeding



or holding the other channels. It operates on a 9-volt battery.

For More Details Circle (48) on Reply Card

Phone Transcriber

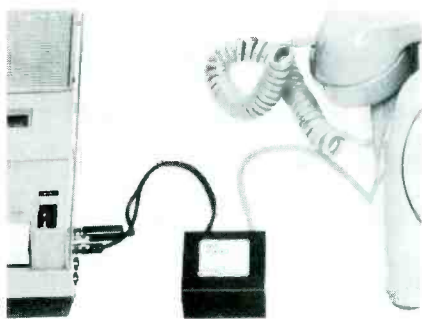

Goodrich Products has introduced Tele-Scribe, a phone transcriber de-

signed to prevent costly mistakes on quotations, pricing, and other pertinent business information.

Tele-Scribe can be used with the telephone and any standard portable tape recorder to provide a permanent record of important conversations. Operating automatically, Tele-Scribe starts and stops the tape recorder every time the phone is used. It connects to any point on the telephone line and does not interfere with phone operation.

Tele-Scribe sells for \$24.95.

For More Details Circle (49) on Reply Card

Speaker Series

Five new speakers, in a variety of sizes and styles, and a Rear Seat Speaker Kit are featured in the "Avanti" Series from the Audiotex Division of GC Electronics.



Pictured is the "Colossus", Cat. No. 30-3054, a 6 X 9 inch dual-cone speaker with a 20-oz. ceramic magnet

For More Details Circle (50) on Reply Card

Stereophone

Superex Electronics Corp. announces the availability of the ST-N "The Newport" stereophone priced at \$19.95 retail.

The Newport features a stainless-steel adjustable headband, fully enclosed ear cups, and all-new design and styling. It has a 30-15,000 Hz frequency response and is designed

for standard stereo jacks. The stereophone weighs 13 ozs.

For More Details Circle (51) on Reply Card

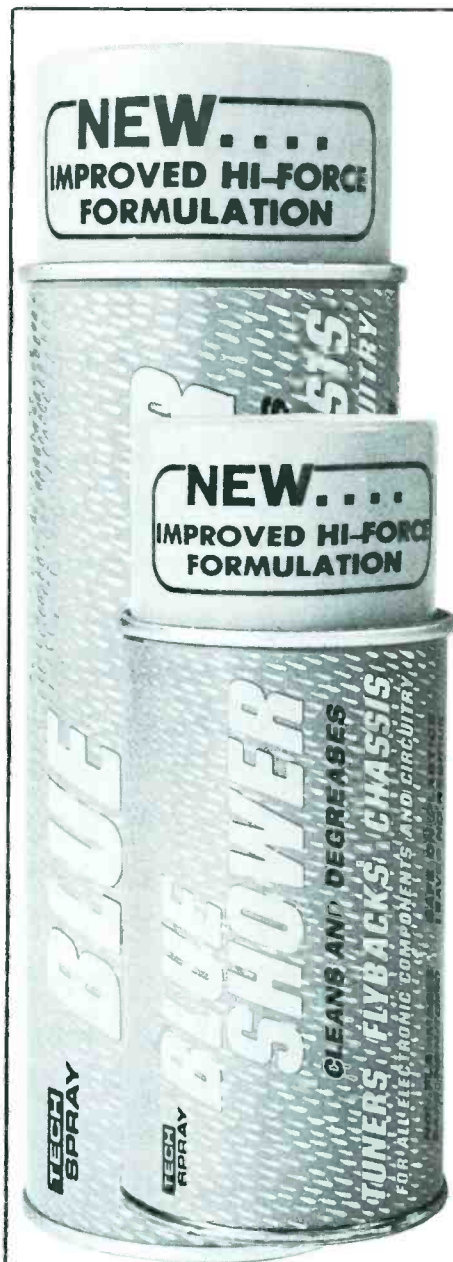

BOTH THE CADDY-CAN AND BENCH SIZE BLUE SHOWER COME WITH TWO SPRAY EXTENSIONS . . . THE REGULAR ONE AND TECH SPRAY'S NEW OMNI-SPRA.

TECH SPRAY

where we find solutions for your problems

P. O. Box 949 • Amarillo, Texas 79105

For More Details Circle (16) on Reply Card

FREE ALARM CATALOG

Full line of professional burglar and fire alarm systems and supplies. 96 pages, 450 items. Off the shelf delivery, quantity prices.



mountain west alarm
4215 n. 16th st., phoenix, az. 85016

For More Details Circle (17) on Reply Card

**Thanks
to you
it's
working**



**The
United Way**



advertising contributed for the public good

antenna systems report

These features supplied by the manufacturers are listed at no-charge to them as a service to our readers. If you want factory bulletins, circle the corresponding number on the Reply Card and mail it to us.

Tunable Trap

A tunable trap that eliminates FM interference from TV sets is offered by **Jerrold Electronics**. Model RFT-300 connects easily to the 300-ohm antenna terminals on the back of any TV receiver or indoor amplifier. The trap can be tuned to industrial radio (72 to 76 MHz) or FM broadcast (88 to 108 MHz) frequency; the user simply watches the TV screen and turns the RFT-300 knob until the FM interference disappears. The tunable notch is 0.25 MHz wide and 18 dB deep.

Model RFT-300 tunable trap is simply packed and sells for \$3.95.

For More Details Circle (52) on Reply Card

"Clam Shell" Display

An eye-catching counter-top display that lets customers see, touch and operate RCA's Mini-State TV antenna before they buy is available from **RCA Parts and Accessories**.



The MLU-1606 display comes with a clear plastic window that is inserted between top and bottom halves of the radome. A bulb in the top half lights the interior of the clam shell so that prospective customers can see the antenna rotate as they operate the hand-held remote control.

For More Details Circle (53) on Reply Card

Solid-State Amplifier



Antennacraft has introduced a solid-state, 20 dB home-type distribution amplifier. The unit has two built-in FM traps and a lighted on-off switch. Rated at 75 ohms, the UVF-1520 has a front-mounted fuse for easy replacement.

For More Details Circle (54) on Reply Card

Distribution Amplifiers



Winegard Company presents Metro-Line distribution amplifiers, featuring high input, high output and low cost.

There are five DA models to choose from: three VHF-FM models and two VHF-UHF-FM models. Extended bandpass (54 to 300 MHz) covers the mid-band and super-bands, making the Metro-Line compatible with CATV inputs for modern and efficient reception systems. By connecting the Metro-Line amplifiers to the cable TV drop that comes into the home, cable TV subscribers can beat the multiple outlet charge for extra sets. Easy to install, the amplifiers allow distribution of the cable signal to additional sets.

Each DA series amplifier is housed in a steel box and contains a lighting-protection diode. They feature low-noise figures; the 82-channel models have separate VHF and UHF amplifiers, no common stages, for higher quality reception. □

For More Details Circle (55) on Reply Card

give
to the
MARCH OF DIMES

catalogs literature

Circle appropriate number on Reader Service Card.

101. Channel Master—has released a consumer products catalog entitled "Channel Master '74—the Natural Sound". The 64-page color catalog features radios, clock radios, cassette player/recorders, modular stereo systems, 8-track equipment, auto entertainers, and portable TV sets.

102. Cornell Dubilier—offers an eight-page SCR-Capacitor brochure describing their paper, paper/film, and film-dielectric capacitors. These units have been designed for applications such as SCR commutating, motor-speed controls, frequency changers, induction heating, electric vehicles, static power suppliers, snubbers, resonant filters, choppers, and static switches.

103. Fordham Radio Supply—has announced a 32-page, illustrated discount mail-order catalog. Designed as a quick reference ordering guide for use by radio and TV technicians, electronic technicians, and hobbyists, the catalog includes tools, service and repair kits, tubes, test equipment, phono cartridges and needles, speakers and microphones, antennas, and components.

104. GTE Sylvania—offers a catalog describing its line of Pathmaker cable communications equipment. The 41-page catalog features Sylvania series 2000 Trunk Amplifier stations and describes the variety of transmission services that can be obtained with the equipment; transportation/distribution amplifier stations, plug-in modules, power supplies, passive devices and accessories are also described.

105. Mountain West Alarm Supply Co.—makes available three books, "Design For Security", "Silent Sentinels" and "Practical Ways To

(Continued on page 57)

bookreview

Color-TV Servicing Guide, Second Edition

Author: Robert G. Middleton

Publisher: Howard W. Sams & Co., Inc., 4300 West 62nd Street, Indianapolis, Indiana 46268

Size: 8-1/2 X 11 inches, 110 pages

Price: \$4.95 softbound

The techniques and procedures employed in troubleshooting a color television receiver are the same as those used in servicing black-and-white receivers, but there are additional color circuits which cause a number of unfamiliar trouble symptoms. The purpose of this book is to familiarize the technician with these symptoms and the possible circuit defects that can cause them; actual color photographs of the television screen showing trouble symptoms are used wherever possible. Symptoms are grouped according to the section of the receiver in which they occur. Although the sync and sweep sections perform the same functions as in a black-and-white receiver, they are discussed because they can affect the color reproduction even though they have no direct effect on the color signal. The other six sections, used only in the color-TV receiver, include color-control circuits, color-sync circuits, chroma-bandpass amplifier, color demodulators, chroma-matrix circuits, and the convergence circuit. General troubleshooting procedures and basic equipment requirements together with the various color-pattern generators and the ways they are used to locate color-TV defects are outlined in the first chapter. The remaining eight chapters are devoted to specific troubles in the various sections of the color-TV receiver. The book also features a discussion of new developments in the color-TV field, including service techniques for hybrid, solid-state, and tube-type receivers. □

cartoon corner



"IT'S A HAM RADIO."

WINEGARD AMPLIFIED PRODUCTS PROVEN IN OVER 1,000,000 INSTALLATIONS. CASE IN POINT: WINEGARD DISTRIBUTION AMPLIFIERS.



For quality and dependability in distribution amplifiers, look to Winegard. You know they're good. Because our distribution amplifiers have specs you can count on and the best reliability in the industry today.

When you install an MATV system you want it to work right . . . and keep on working that way. You want a headend amplifier that won't give you headaches. No matter what size systems you install Winegard offers the most trouble-free circuitry around . . . and at the most reasonable cost around.

On your next commercial system start out with a Winegard distribution amplifier. There's a model just right for every size and type of installation. We invite comparison!

Best TV products for Best TV reception



Winegard Company • 3000 Kirkwood Street • Burlington, Iowa 52601

For More Details Circle (18) on Reply Card

LOOK TO Lenk FOR YOUR SOLDERING TOOLS

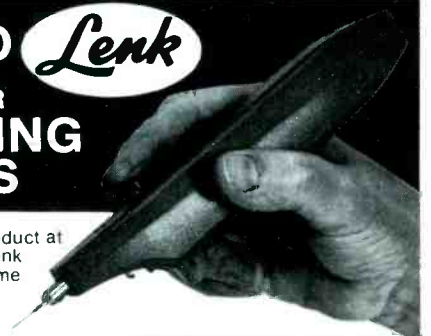

You'll find the right product at the right price in the Lenk line — made by long-time specialists in soldering equipment.

CORDLESS

Battery powered. Built-in light. Fits easily into a tool box. Can be used while re-charging. Over 700°F tip temperature. Heats almost instantly. Very light — very useful!



PENCIL TYPE IRONS

Lightweight, cool handles, screw-in tips.



PACEMAKER

An instant type gun at low, low cost. Lightweight — no heavy transformer. Fast heating. Thermostatic action. Long, thin reach. Needs no stand, rests with tip upright. Interchangeable tiptlet.

AND OTHERS —

ALL MADE IN THE U.S.A. BY SKILLED CRAFTSMEN
See the Lenk line where quality soldering tools are sold

SINCE 1864

WALL-LENK MFG. CO.

WORLD'S LARGEST MANUFACTURER OF SOLDERING IRONS
KINSTON, N. C. 28501

photo**fact**bulletin

PHOTOFACT BULLETIN lists new PHOTOFACT coverage issued during the last month for new TV chassis.

ADMIRAL

Chassis T41K10-1A/-1B, T42K10-1A, T43K10-1A 1412-1

BRADFORD

1171A34 (WTG-79319) 1413-1

CATALINA

122-2117, 122-2119 1411-1

CHANNEL MASTER

6128A, 6129A 1410-1

CORONADO

TV2-2044A, TV2-2054A, TV2-2064A, TV2-2076A 1408-2

EMERSON

25EC23W, 25EC24S (Ch. 30K2091-2) 1415-1

GENERAL ELECTRIC

Chassis 9SF, 12SF, 15SF (Code EN271 and higher) 1415-2

HITACHI

V-17 (Ch. SS-A) 1414-1

J. C. PENNEY

685-2203 (855-1921) 1414-2

J. C. PENNEY

2864/A, 2866/A 1415-3

MAGNAVOX

Chassis T981-01/-02/-03/-04,
T982-01/-02/-03,
T987-01/-04 1411-2

Remote Control Receiver 704082-1 1411-2-A
Remote Control Receiver 704085-1 1411-2-B

PHILCO-FORD

Chassis 3CN20, 3CP30, 3CP31 1410-2

RCA

AS157ER, AS158WR (Ch. KCS168XH) 1408-3
Remote Control Receiver, Transmitter KRT5D/E . 1408-3-A

SEARS

562.40270300/301, 562.40290300 1409-2

SHARP

2W-28 1412-3

SYLVANIA

Chassis EO3-1 1414-3

WARDS AIRLINE

GAI-11634A/B, GCI-13162A/B 1409-3

ZENITH

Chassis 19EC13, 19EC22 1413-3

reader's exchange

(Continued from page 9)

Needed: Schematic and service information for model 480 multimeter, manufactured by Radio City Products Company. Will buy or copy and return.

Howard H. Price
3832 West Gladys Avenue
Chicago, Illinois 60624

Needed: Dumont type 316 probe, used as accessory with Dumont 303 oscilloscope.

D. Tylicke
253 Falmouth Avenue
Elmwood Park, New Jersey 07407

Needed: Owners manual for a Heathkit DX-35 transmitter. Will buy or copy and return.

William H. Hall, Jr.
5095 Sandy Avenue S.E.
Canton, Ohio 44707

Needed: Schematic and a newer tube-check manual for an Electronic Measurements Corporation model 211 tube checker.

Ronald Nation
2175 Pacific Avenue, Apt. B
Costa Mesa, California 92627

Needed: Schematic and power transformer for a Graetz Melodia model 1118E.

Staff's TV
2902 West Platte Road
Riverside, Missouri 64150

Needed: Schematic and operating book for a Dumont model 164 scope.

R. A. Freeman
33 Pictou Road
Truro, Nova Scotia B2N 2R9

Needed: Schematic for a Philco radio chassis 38-5.

Charles Andrews
175 Brookridge Drive
Rochester, New York 14616

Needed: Schematic for a Hickok model 850-P portable transistor analyzer. Will buy or copy and return.

Louis F. Flor
1421 Yew Circle
Healdsburg, California 95448

Needed: Schematic for Tek model 105 square-wave generator. Will buy or copy and return.

Ed Hansen, Jr.
Box 2064
Akron, Ohio 44309

Catalogs and Literature

(Continued from page 54)

Prevent Burglary and Illegal Entry", which discuss security planning, management, locks, alarms, and electronics. A folder with detailed summaries of these books and how to buy them may be obtained by writing to Mountain West.

106. Nortronics Company—has introduced the fifth edition of their Recorder-Care Manual. The two-color, 32-page manual discusses magnetic heads, principles of magnetic recording, and recorder maintenance, and contains a catalog section which illustrates and describes recorder-care products by Nortronics.

107. PLC Electronics—announces the availability of a detailed 32-page catalog which lists 17 professional security systems designed for installation by electronic service technicians.

108. Howard W. Sams & Co.—offers the new Audel Book Catalog, a colorful 48-page catalog describing 98 books which were written for the do-it-yourselfer, homeowner, craftsman, or student. Some of the books included in the catalog are "Electrical Library", "Practical Electricity", "Radio and Television Library", and "New Electric Science Library".

109. Simpson Electric—has published a 40-page catalog which describes the complete line of Simpson test and measurement devices available from distributors. Catalog 4200 lists over 1500 types, styles, sizes, and ranges of panel meters, more than 100 meter relays, and a variety of general and special purpose test equipment.

110. Triplett Corp.—has introduced an eight-page, four-color brochure on its new line of sound measuring, monitoring, and recording equipment. "A Better Way To See Sound" illustrates Triplett's sound level meters, dosimeter, integrator, calibrators, and accessories. It provides detailed physical and electronic specifications, including dimensions, weights, decibel ranges, performance parameters, operating

characteristics, and environmental considerations, and has tables showing typical sound pressure levels generated by various industrial and other operations.

111. Tucker Electronics Co.—has announced the availability of a 160-page instrument catalog. Over 5000 test instruments are listed by nearly 600 manufacturer names. Many reconditioned, new and used sets are available, and a variety of rental and purchase finance plans are offered. The catalog features 18 sections divided by products category, and backed by an inventory of over 15,000 instruments. □

Servicing Zenith

(Continued from page 40)

Centering problems

Because the transistors are direct coupled to the yoke, vertical centering is affected by the balance of the two emitter currents. If no centering correction is needed, the DC voltage at W6 should be virtually zero. A control is provided on the module to change slightly the bias of the two output transistors. Because one is PNP and the other NPN, the emitter currents are affected in reverse. In actual servicing, the DC voltage might be slightly positive or negative at module terminal W6.

This balance of currents, plus the division of sweep so one transistor supplies the top part of the raster, and the other transistor deflects the bottom half, can produce a rather unique symptom. When one of the output transistors is open, there is insufficient height, and it is all either at the top or at the bottom of the screen (see Figure 7). The linearity is not as poor as you might imagine under those abnormal conditions, because of the yoke current feedback entering through module terminal U4. This feedback is the main reason why no linearity control is needed.

Conclusion

Solid-state TV receivers have far less similarity of circuitry between the various brands and models than was true for tube-powered sets. This makes it even more imperative for each technician to **understand** the basic action of each circuit, in

addition to knowing about all of the unique features that can change troubleshooting so radically.

If there are any solid-state circuits you don't understand, write to the editor with all the details. We will try to explain all those mentioned most often. □

(Continued from page 48)

Solution to:

FUN AROUND OHM

1. AquadaG
2. Glitch
3. HarmonicS
4. SemiconductorR
5. ReactanceE
6. ElectrothermaL
7. LamberT
8. TransistoR
9. ResidualL
10. Lithium
11. MonochromE
12. ElectronicC
13. CeramiC
14. CoaxialL
15. LoraN
16. NeutrodynE
17. ElementT
18. TetrodeS
19. Switch
20. HeavisidE
21. EtchanT
22. ToroidaL
23. Linearity

*Start with 115 points
and deduct 5 points for
any part you may not
have answered correctly.*

Your rating:

65 - 70 Passing.

75 - 80 Better.

85 - 95 Good.

100 - 110 Excellent.

115 **PERFECT!** You're entitled to an imaginary blue ribbon!

FREE CATALOG
HARD-TO-FIND PRECISION TOOLS
Lists more than 2000 items—pliers, tweezers, wire strippers, vacuum systems, relay tools, optical equipment, tool kits and cases. Also includes ten pages of useful "Tool Tips" to aid in tool selection.
JENSEN TOOLS
4117 N. 44th Street, Phoenix, Ariz. 85018

For More Details Circle (20) on Reply Card

OWN YOUR OWN PICTURE TUBE REBUILDING BUSINESS
With Lakeside Industries rebuilding equipment you can rebuild any picture tube!
For complete details send name, address, zip code to:
LAKE SIDE INDUSTRIES
3520 W. Fullerton Ave.
Chicago, Ill. 60647
Phone: 312-342-3399

For More Details Circle (21) on Reply Card

The MARKETPLACE

This classified section is available to electronic technicians and owners or managers of service shops who have for sale surplus supplies and equipment or who are seeking employment or recruiting employees.

Advertising Rates
in the Classified
Section are:

- 25 cents per word (minimum \$3.00)
- "Blind" ads \$2.00 additional
- All letters capitalized 35 cents per word

Each ad insertion must be accompanied by a check for the full cost of the ad.

Deadline for acceptance is 30 days prior to the date of the issue in which the ad is to be published.

This classified section is not open to the regular paid product advertising of manufacturers.

FOR SALE

TV & RADIO TUBES 36c EA!! Free color catalog. Cornell, 4221 University, San Diego, California 92105. 2-74-6t

USE YOUR SCOPE (ANY MODEL, NO REWIRING) TO TEST TRANSISTOR IN/OUT CIRCUIT. SIMPLE INSTRUCTIONS \$1.00. SCHEK TECHNICAL SERVICES, 8101 SCHRIDER ST., SILVER SPRING, MARYLAND 20910. 10-73-12

UNUSUAL SURPLUS AND PARTS Catalog. \$1. ETCO Electronics Dept. E.S., Box 741, Montreal "A" H3C 2V2 12-73-12t

TELEVISION SALES/SERVICE: 24 years - original owner - Retirement. JENKINS ELECTRONICS, 2504 Edgewater Dr., Orlando, Florida 32804 7-74-1t

IMPORT DIRECT. Taiwan Electronics distributors & manufacturers names, addresses. \$3. Reidel, Box 9603-L, Denver, Co. 80209. 7-74-1t

SAM'S PHOTOFACTS - 1 Thru 1169, B&K Test Equipment, New. Price on request. Paul Vaughn, 1702 N. College, Fayetteville, Ark. 72701. 7-74-1t

WESTON 984 Sweep Generator and 985 Calibrator alignment equip. Mint condition. \$160.00 w/shipping. J. H. Cummins 6020 'A' St., Phila., Pa. 19120. 215-424-7393. 7-74-1t

MOTOROLA PANELS mounted in TS-934 or TS-938 drawer. All new with minor mechanical damage to drawer frame. Includes tuners. CA, BA, KA, FA, HA, and ZA panels. With shipping \$80.00. Bennetts, 2256 Sheridan, Zion, Ill. 60099. 7-74-1t

EDUCATION-INSTRUCTION

REPAIR TV TUNERS—High Earnings; Complete Course Details, 12 Repair Tricks, Many Plans, Two Lessons, all for \$2. Refundable. Frank Bocek, Box 3236 Enterprise, Redding, Calif. 96001. 6-74-6t

NOW! Master Solid State Vertical Oscillator-Output Circuit problems. Latest instruction teaches current circuitry. \$1 brings lesson, details. Reidel, Box 9603, Denver, Colorado 80209. 7-74-ft

WANTED

WANTED: C.R.T. Rebuilding Unit, Lakeside 1502 preferred. Write stating price: Joe Kopp, Box 764, Oceanside, Ca. 92054. 7-74-1t

MODERN up-to-date TV shop needs a good electronic technician. Owner would also sell out, due to our age. Town of 3000 fine people. Motorola & RCA franchise. Business established since 1937. Uker's Radio & TV, Clarion, Iowa 50525. 7-74-1t

SERVICES

OSCILLOSCOPE REPAIRS. Send unit or write for details. ONG ELECTRONICS, INC., Box 209, Corning, New York 14830. 6-74-3t

advertisers' index

B & K Div., Dynascan Corp	7
Bussmann Mfg. Div., McGraw-Edison	27
Castle TV Tuner Service ...	59, Cover 4
Cleveland Institute of Electronics ...	59
Essex International, Inc.	19
The Finney Company	52
Gem City Tuner	10
General Electric Company	47
Heath/Schlumberger Instruments	26, 59
Hewlett-Packard	50, 51
Jensen Tools and Alloys	57
Lakeside Industries	57
Mountain West Alarm Supply Co	53
Philips Test & Measuring Instruments, Inc.	61
Precision Tuner Service. 61, 63, Cover 4	
Howard W. Sams & Company, Inc.	3, Cover 3
Sola Electric	63
Sperry Tech, Inc.	35
Sprague Products Co ...	11, 63, 65
GTE Sylvania—Consumer Renewal	1, 17
Systems Electronics, Inc.	9
Tech Spray	53
Tektronix, Inc.	29
Tucker Electronics Co.	21
Tuner Service Corp	5
Wall-Lenk Mfg. Co.	55
Winegard Company	55
Zodiac Distributors	47

Wanted!

700,000
busy executives
who can:

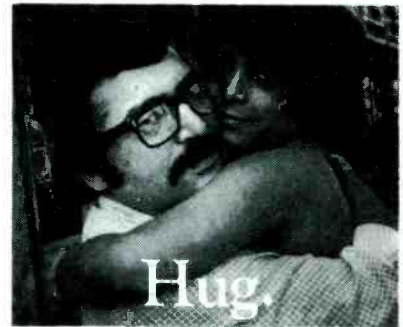

If you can spend some time, even a few hours, with someone who needs a hand, not a handout, call your local Voluntary Action Center. Or write to "Volunteer," Washington, D.C. 20013.

We need you. 
The National Center for
Voluntary Action.

 advertising contributed for the public good

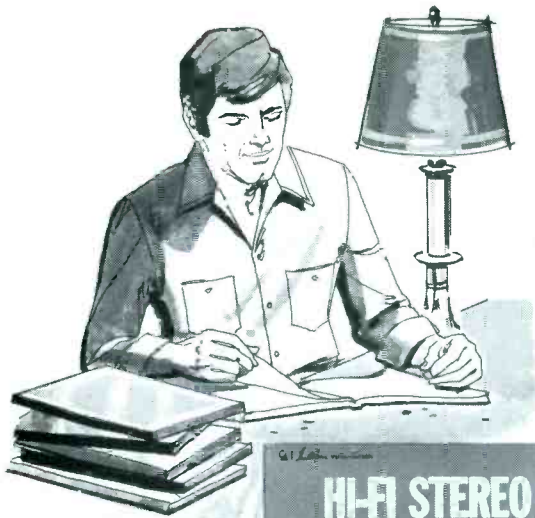

The more specialized your field, the more you'll need these books



HI-FI STEREO SERVICING GUIDE—2nd Edition

by Robert G. Middleton

Anyone servicing a-m tuners, fm tuners, stereo-multiplex units, and audio amplifiers can gain valuable service direction and assistance from this guide. It also covers hi-fi speaker installations, system evaluation, troubleshooting, and methods of verifying test equipment performance. 104 pages, softbound. No. 21075 \$4.50

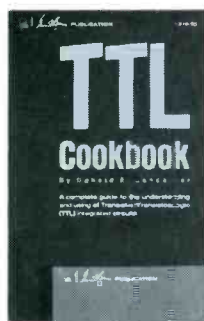

TTL COOKBOOK

by Donald E. Lancaster

Transistor-Transistor Logic has opened up a fantastic number of applications for digital circuitry. It is not only better than traditional analog circuits, it is often cheaper. This timely book, by the author of the famous *RTL Cookbook*, explains what TTL is, how it works, and how to use it. 336 pages, softbound. No. 21035 \$8.95

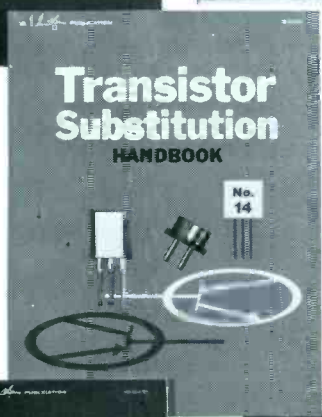

TRANSISTOR SUBSTITUTION HANDBOOK—14th Edition

by The Howard W. Sams Engineering Staff

Since exact replacement of transistors is not always possible, this book fills a definite need. It lists substitutions for over 100,000 bipolar transistors. Both computer-selected substitutes and manufacturer-selected, general-purpose replacements are given. An updated and invaluable reference for the serviceman. 152 pages, softbound. No. 21040 \$2.95

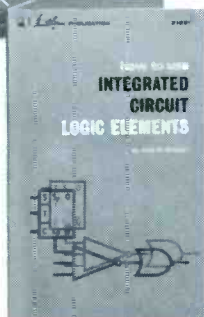

HOW TO USE INTEGRATED-CIRCUIT LOGIC ELEMENTS—2nd Edition

by Jack W. Streater

Lacking previous experience with digital logic circuits, the engineer or technician will be at a complete loss when he enters the field of integrated-cir-

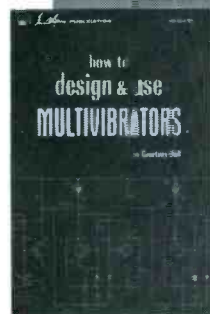

cuted logic electronics. This practical book helps him over that hurdle. It opens with a necessary explanation of the binary number system and Boolean algebra and progresses logically to the practical problems and limitations involved in preparing to work in this new field. A glossary of digital terms is included. 160 pages, softbound. No. 21081 \$4.50

HOW TO DESIGN AND USE MULTIVIBRATORS

by Courtney Hall

This book examines the various types of multivibrators at the introductory level. It explains how multivibrator circuits work in switching rapidly from one state to another, how they can be designed using a minimum number of components, and how they can be applied in practical circuits. Many specific projects for multivibrator circuits are covered. 96 pages, softbound. No. 21043 \$3.95

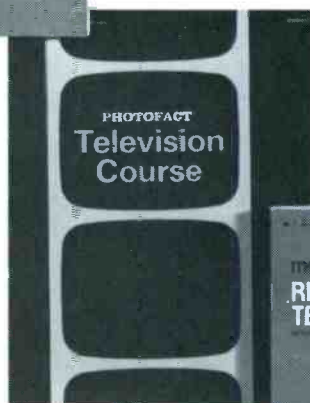

PHOTOFACT® TELEVISION COURSE—4th Edition

by The Howard W. Sams Editorial Staff

This book has provided the basic knowledge for thousands who have become skilled in the field of television engineering and service. Newly updated, it presents a complete course in black-and-white television, describes the functions of important circuits, and is supported by numerous schematics. Each chapter is followed by questions, with answers at the back of the book. 208 pages, softbound. No. 20981 \$6.95

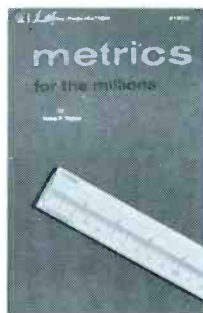

MODERN RECORDING TECHNIQUES

by Robert E. Runstein

In explaining the intricacies of recording pop music, this book fills a gap that has been neglected or overlooked. It is of particular value to the recording engineer since it covers equipment, controls, and operating techniques currently in use in recording studios. 368 pages, softbound. No. 21037 \$9.95

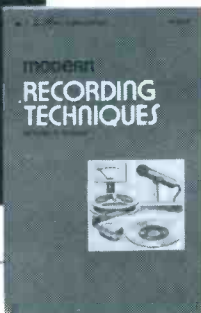

METRICS FOR THE MILLIONS

by Rufus P. Turner

Here is an essential reference manual for all who will be affected by the coming changeover from our present system of measuring to the metric system. Each of the various metric units is covered, and examples show how to convert from U.S. to metric and from metric to U.S. 96 pages, softbound. No. 21036 \$3.50



HOWARD W. SAMS & CO., INC.

4300 West 62nd Street, Indianapolis, Indiana 46206

Order from your electronics parts distributor, or mail to Howard W. Sams & Co., Inc. Send books checked at right. \$ _____ enclosed. Please include sales tax where applicable.

- 21075 21043
 21035 20981
 21040 21037
 21081 21036

ES 074

Send FREE 1974 Sams Book Catalog 007146

Name _____

Address _____

City _____ State _____ Zip _____

For More Details Circle (2) on Reply Card

A Giant ... Steps Forward!

..... a truly fantastic, **BRAND NEW,** TV Service
Instrument

More than two years in development.
Modular microcircuit construction.
Masterpiece of miniaturization.

MASTER SUBBER™ MARK V

The GIANT in a tiny package



Designed for servicing the **ENTIRE** signal circuit system of any Color or Black & White Television receiver . . . by signal substitution!

Substitutes the following signal stages:

- VHF Tuner.
- Each video i.f. stage.
- Video detector stage.
- Video amplifier stage.
(Positive and negative going signals available simultaneously)
- 4.5 MHz sound i.f. amplifier stage.
- Sound limiter stage.
- Sound detector stage.
- Audio amplifier stage.

Provides tests for:

- UHF tuner.
- Antenna system.
- AGC system.

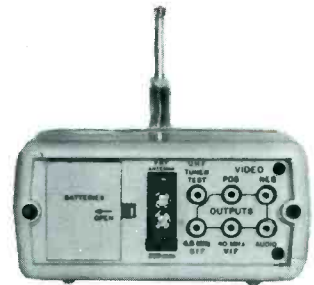

Use on the bench or in the home. Equipped with wall plug-in transformer for 120-vac line, instrument automatically changes over to internal battery power when transformer is disconnected.

Inbuilt monopole antenna allows use without connection of outside antenna in prime signal areas.

Inbuilt monitor loudspeaker with separate level control.

Video carrier level meter may be calibrated against Master Gain Control for the area in which the instrument is used, to afford true field strength measurements.

Lightweight . . . and measures a mere 6.5" x 6.5" x 3.25" exclusive of knobs, handle and antenna.

Complete with connecting cables and instructions.

You get all this for \$169.95 . . . at your stocking distributor.

. . . or write for more details and complete specifications.



CASTLE TV TUNER SERVICE, INC.

5701 N. Western Ave., Chicago, Illinois 60645 • Phone: (312) - 561-6354

In Canada: Len Finkler Ltd., Ontario

For More Details Circle (3) on Reply Card